

Two Point Perspective.

Today you will learn how to draw shapes using two point perspective.

The position of the horizon (or eye level), is very important, and affects the shape of the object being drawn.

Start off by drawing a 5mm border on your sheet.

5mm

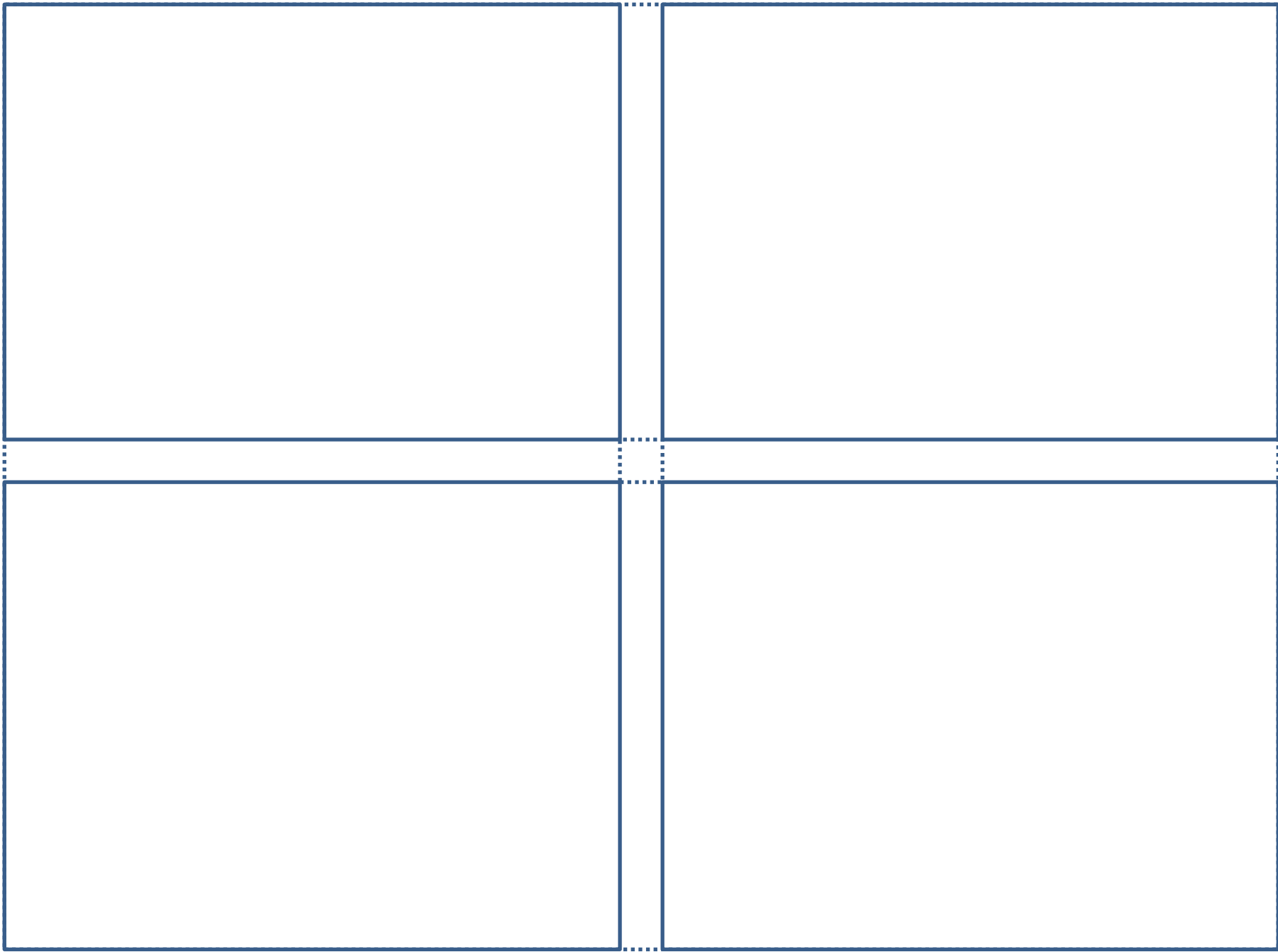

Start off by drawing a 5mm border on your sheet.

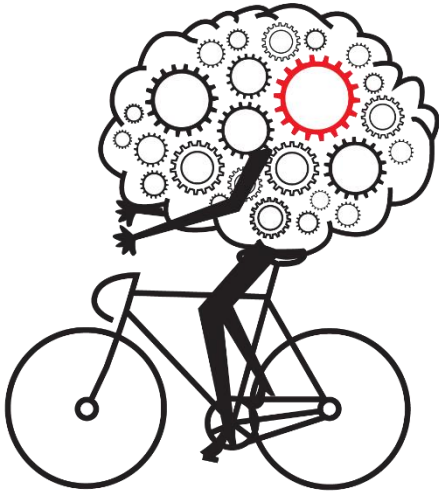

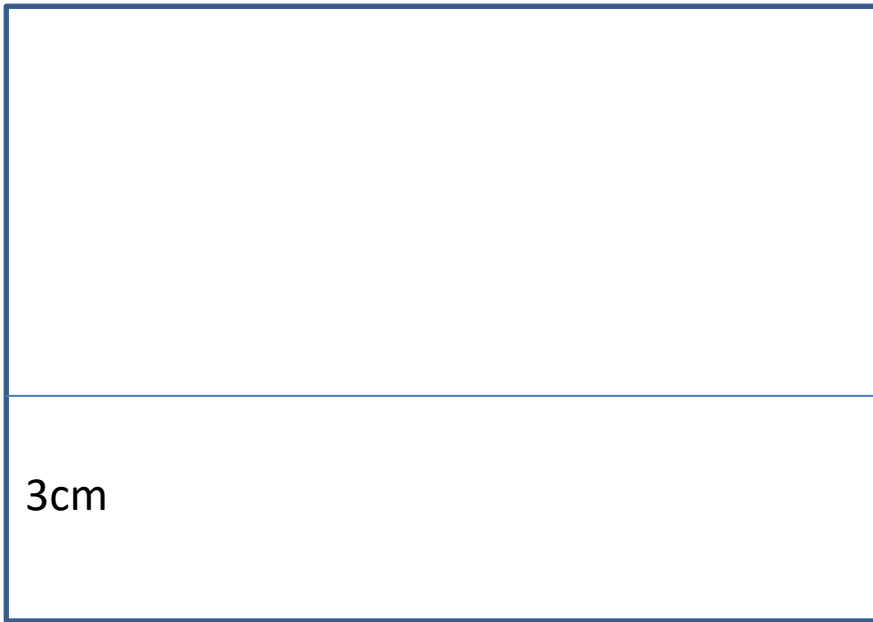

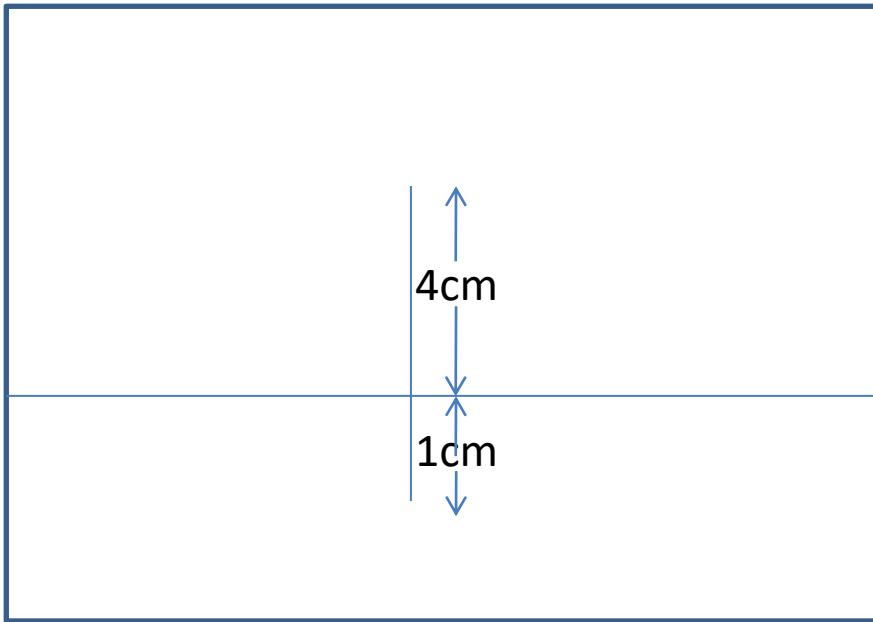

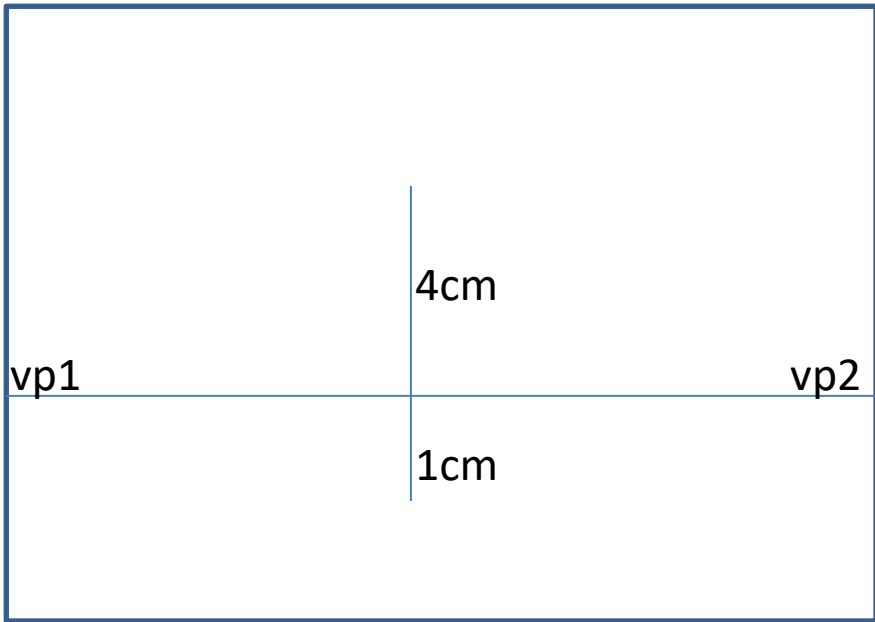

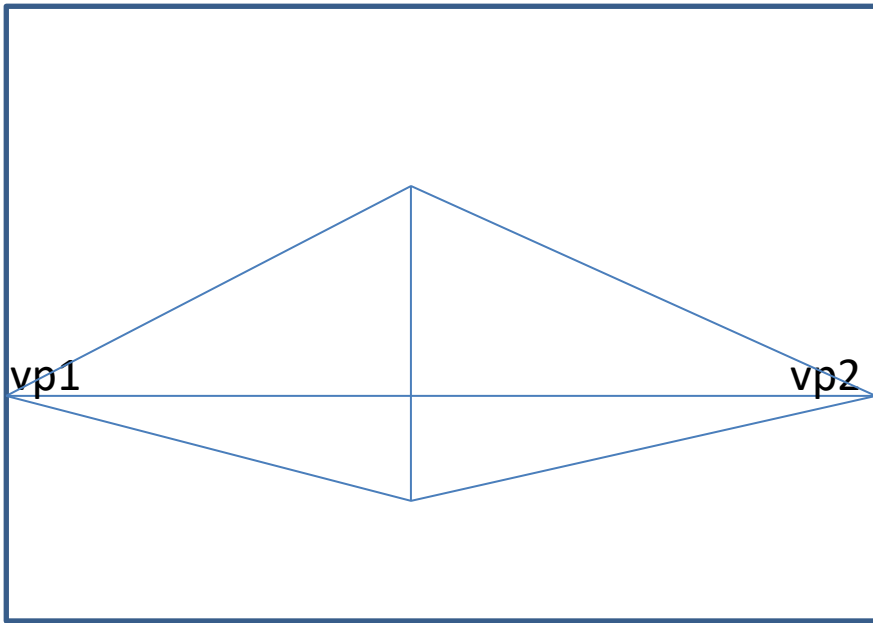

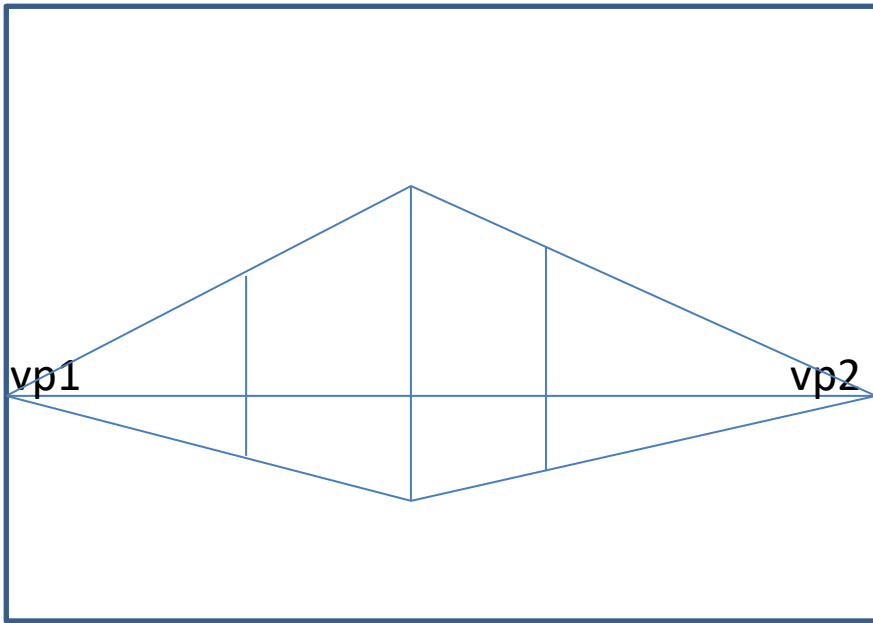

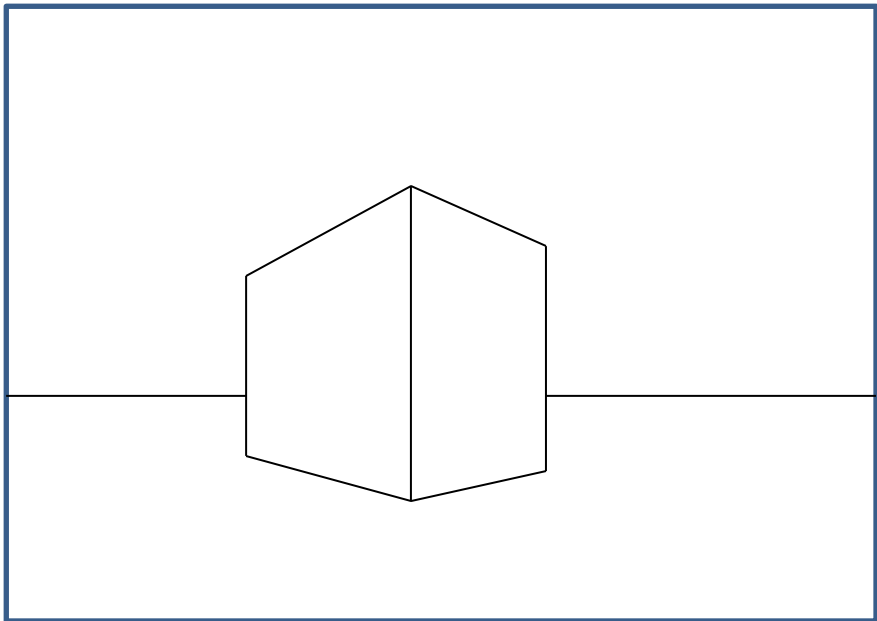

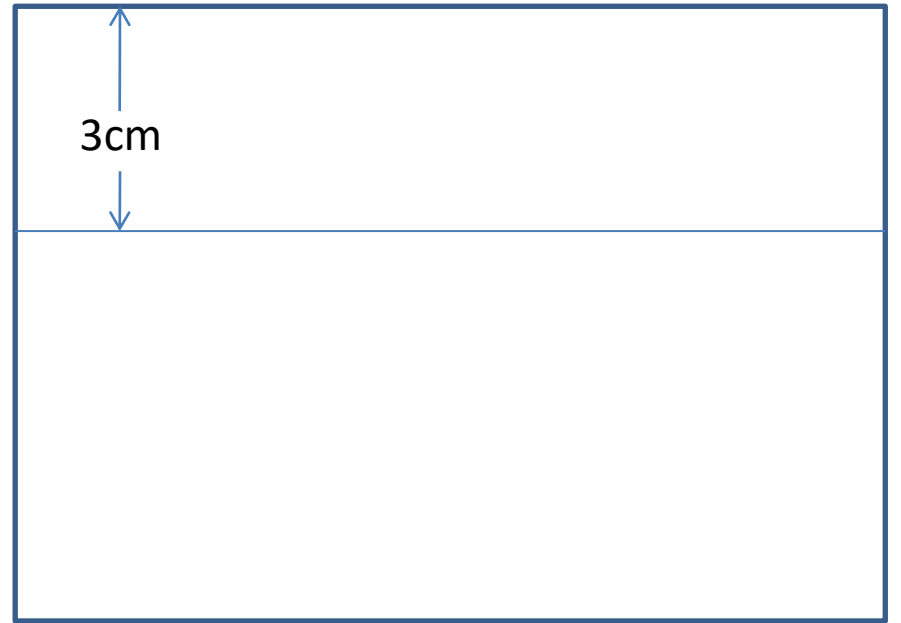
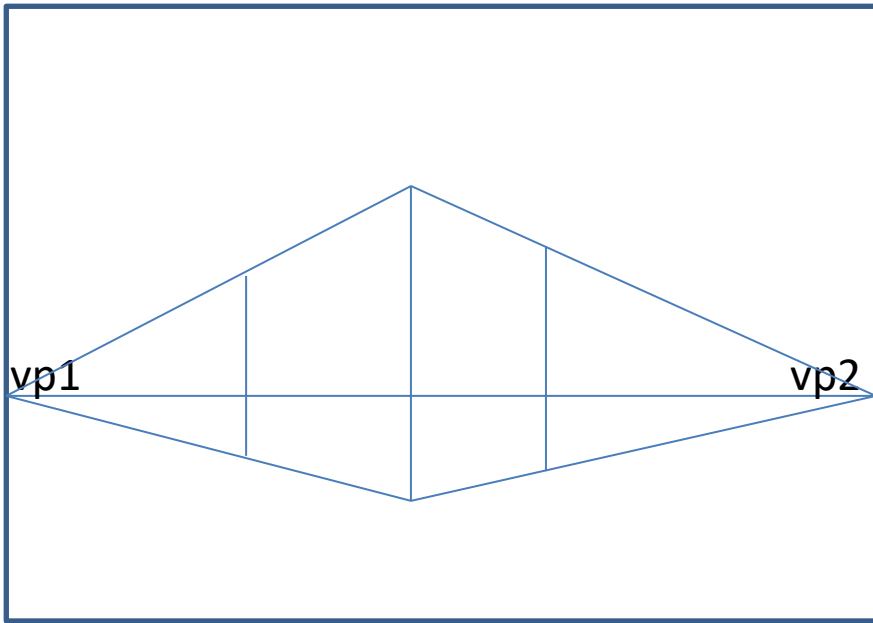

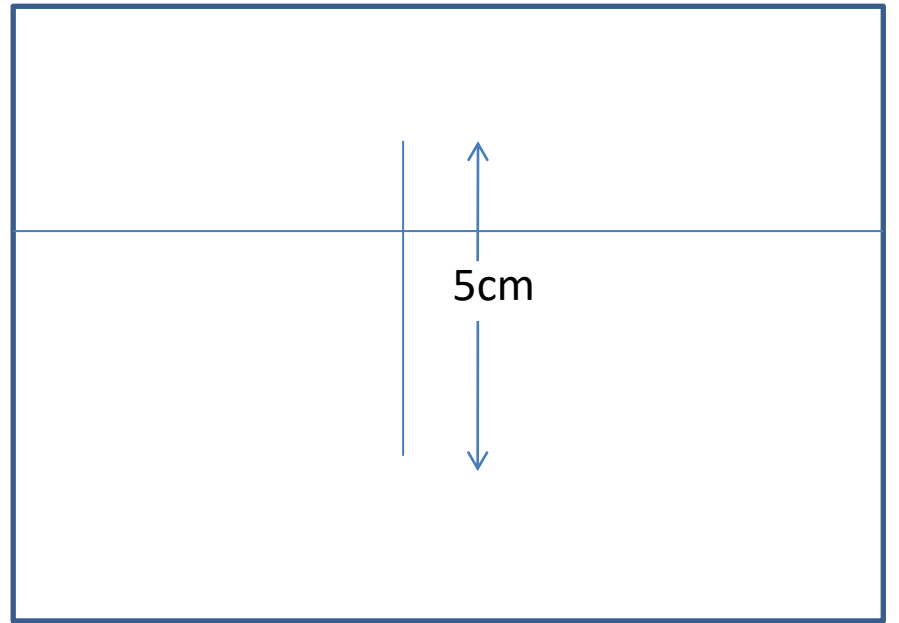
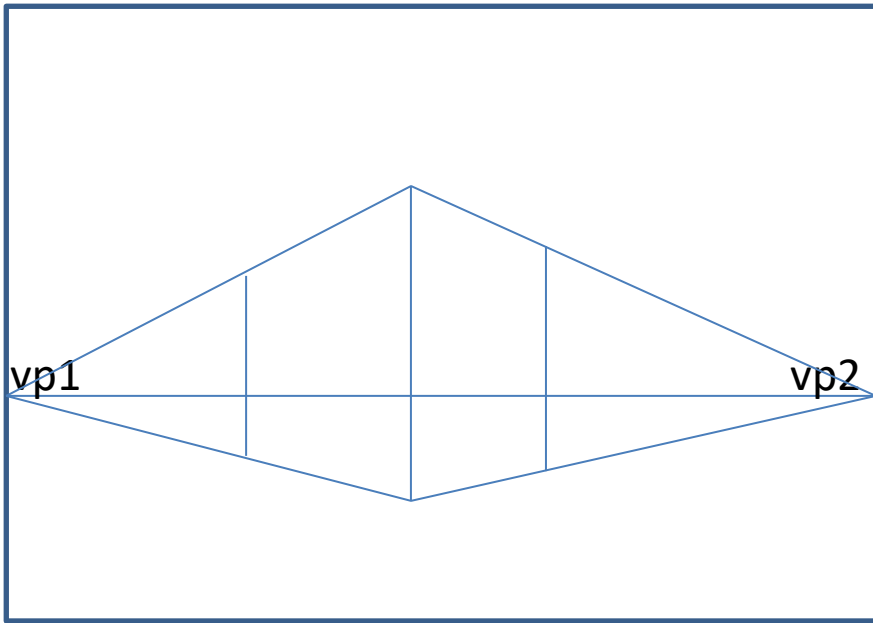

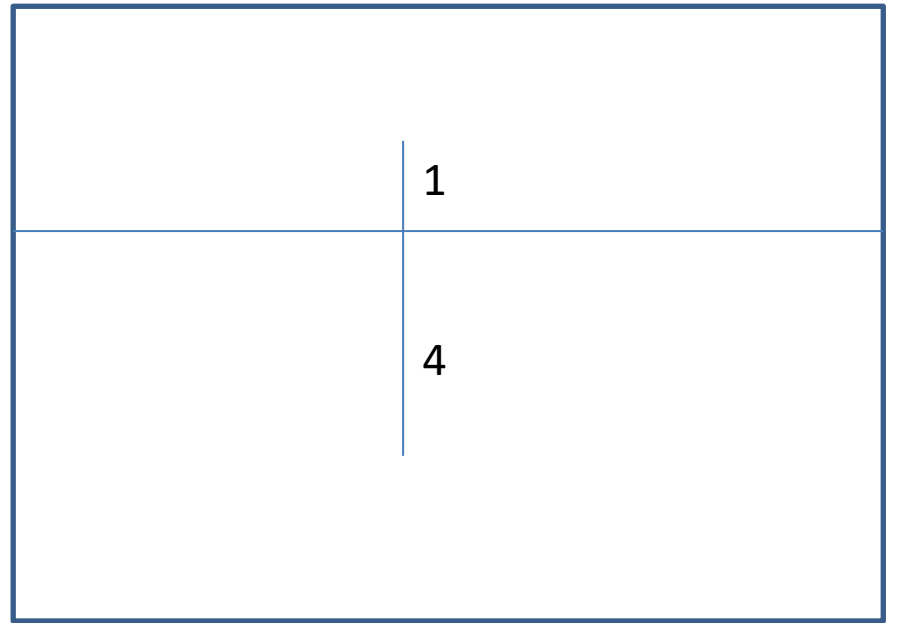
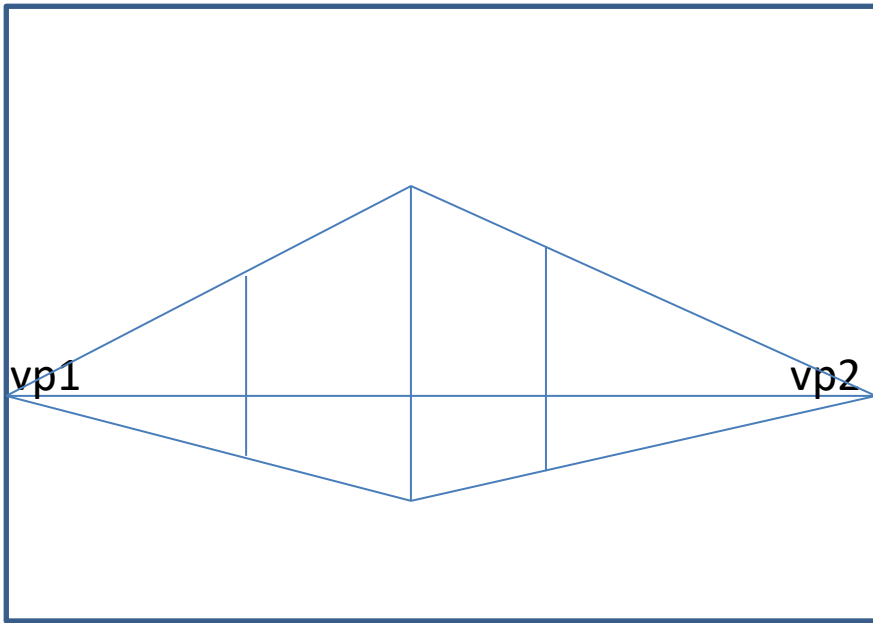

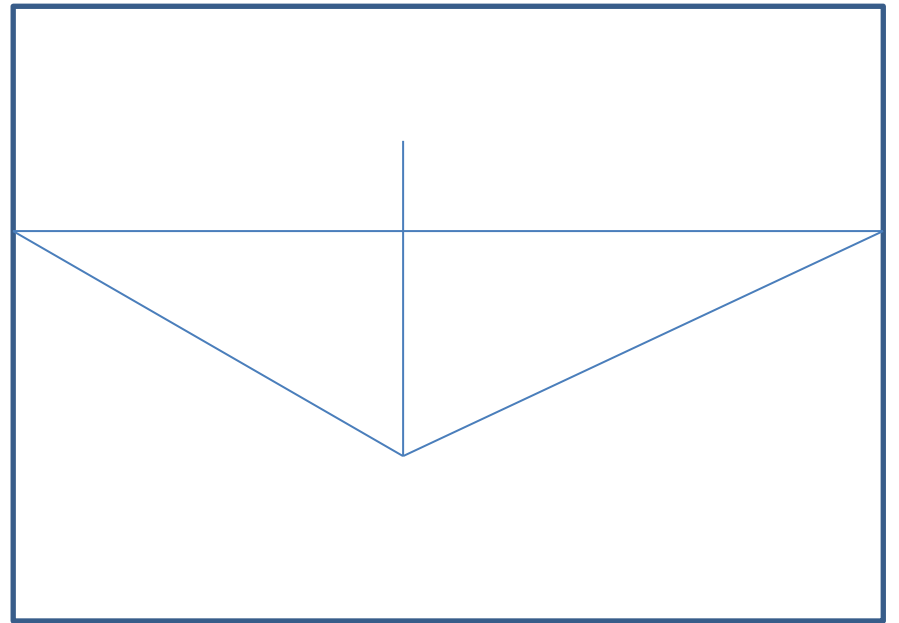
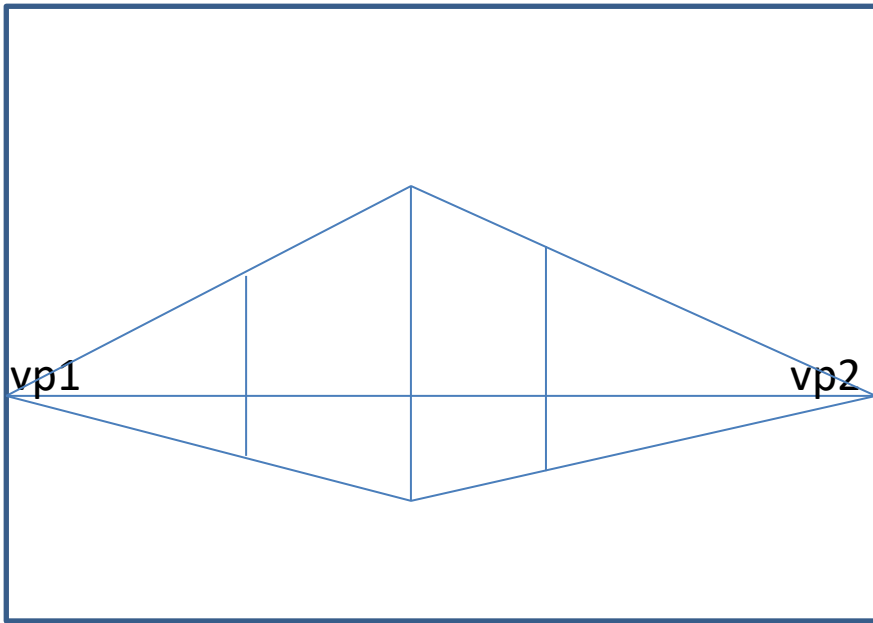

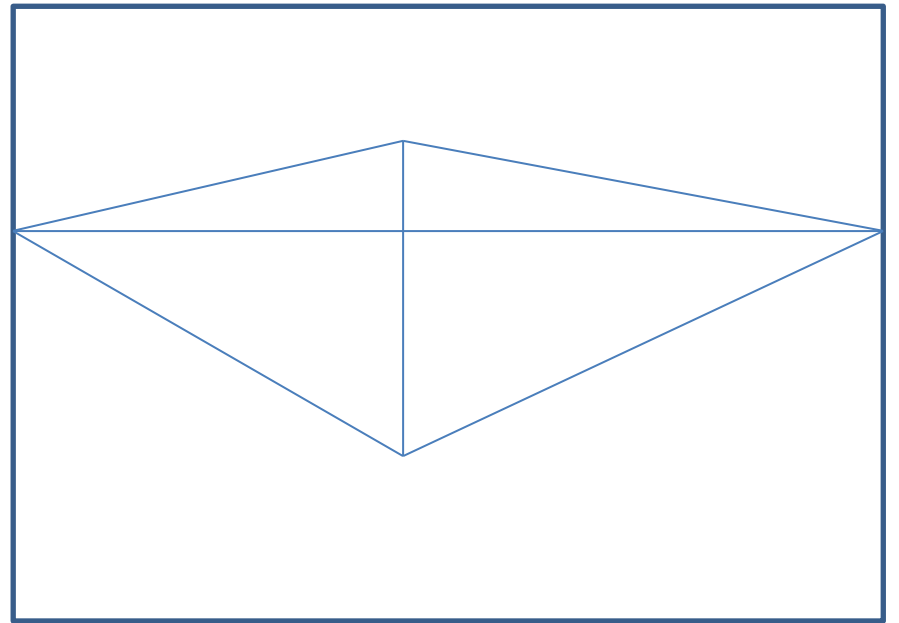
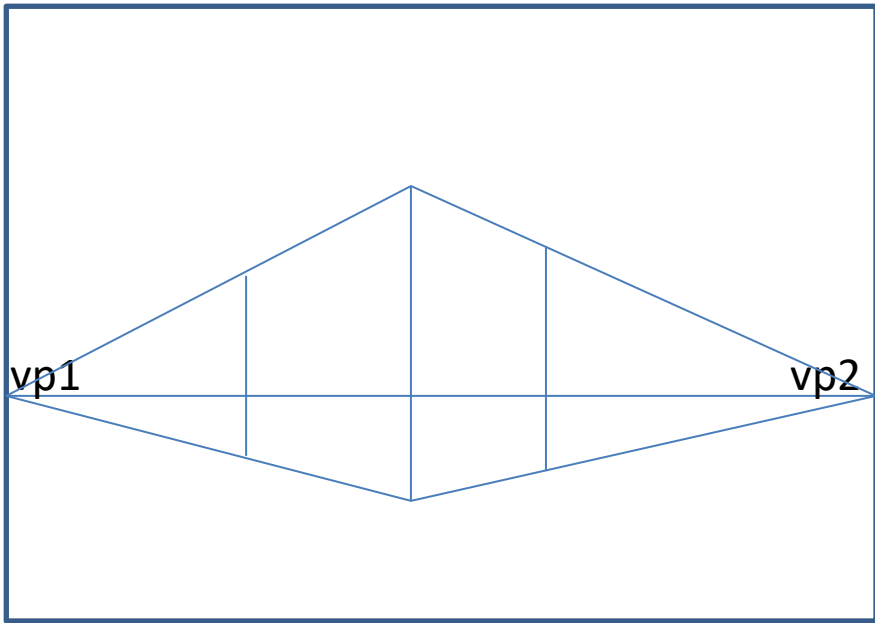

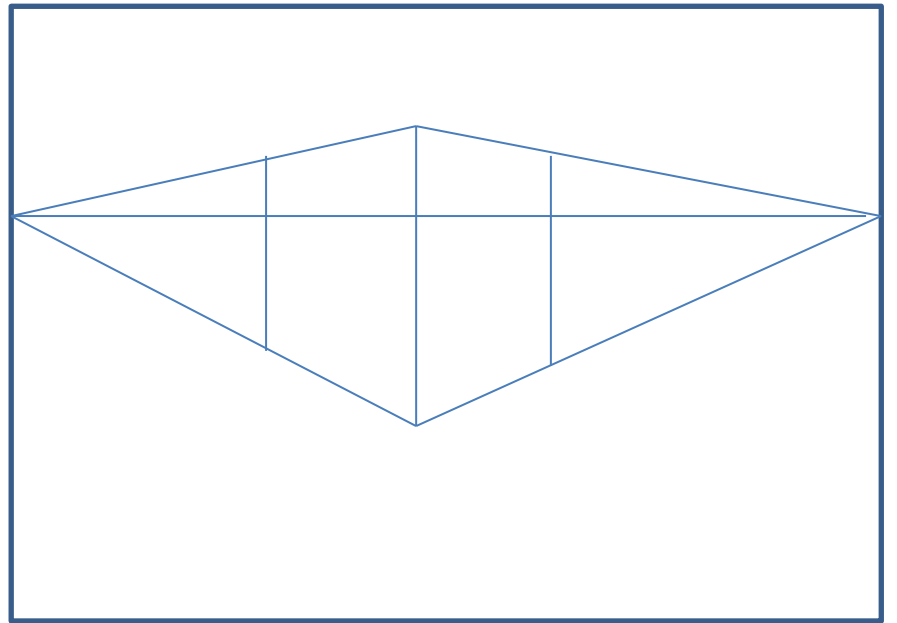
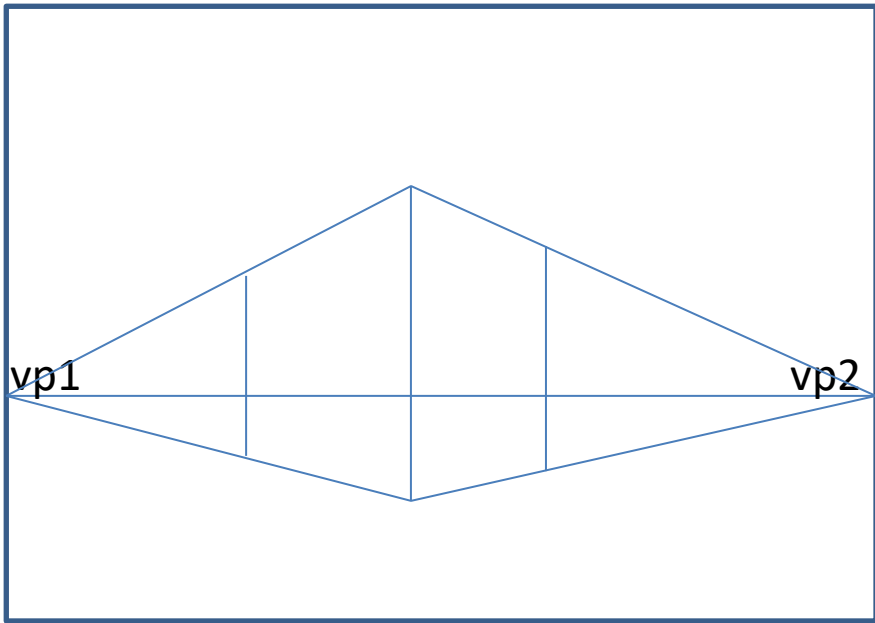

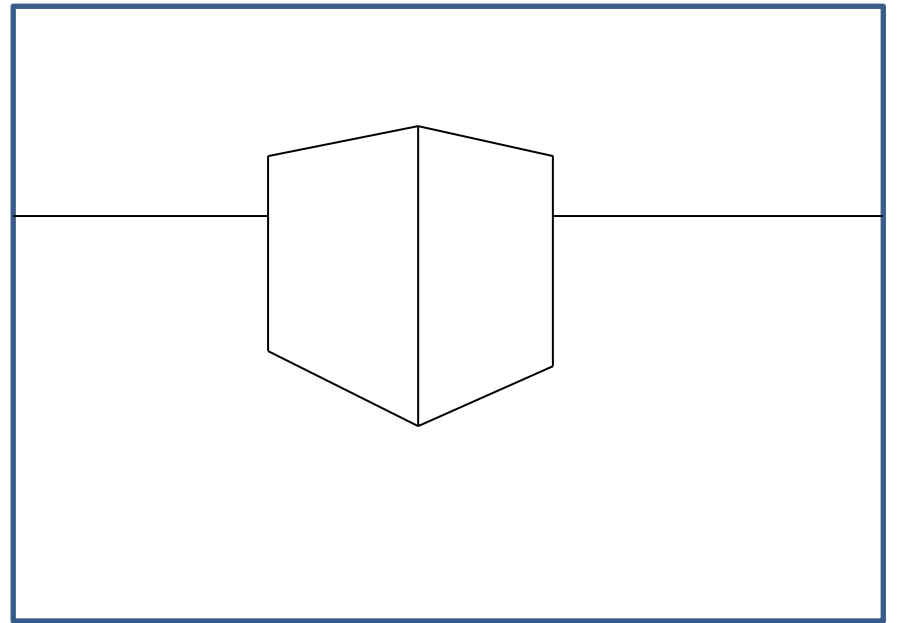
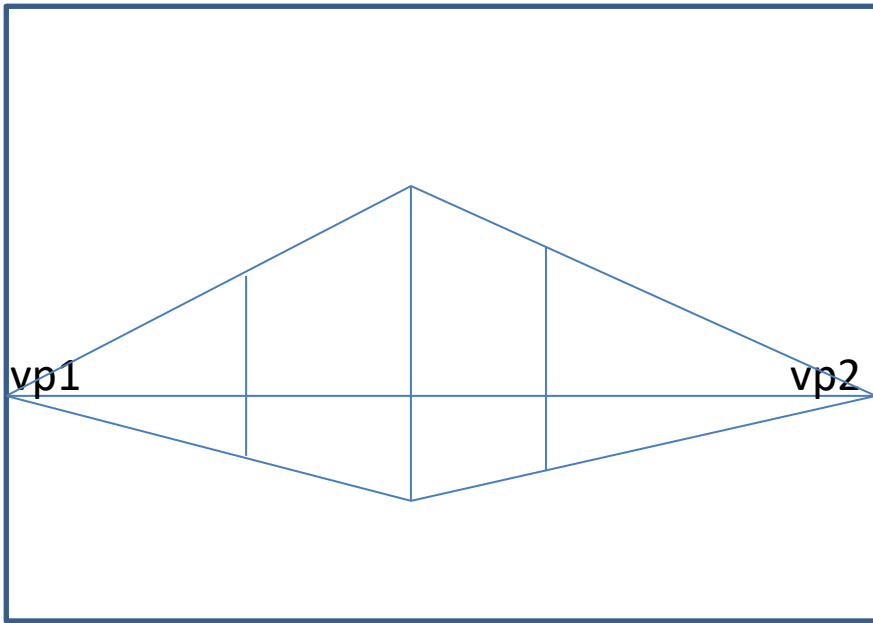

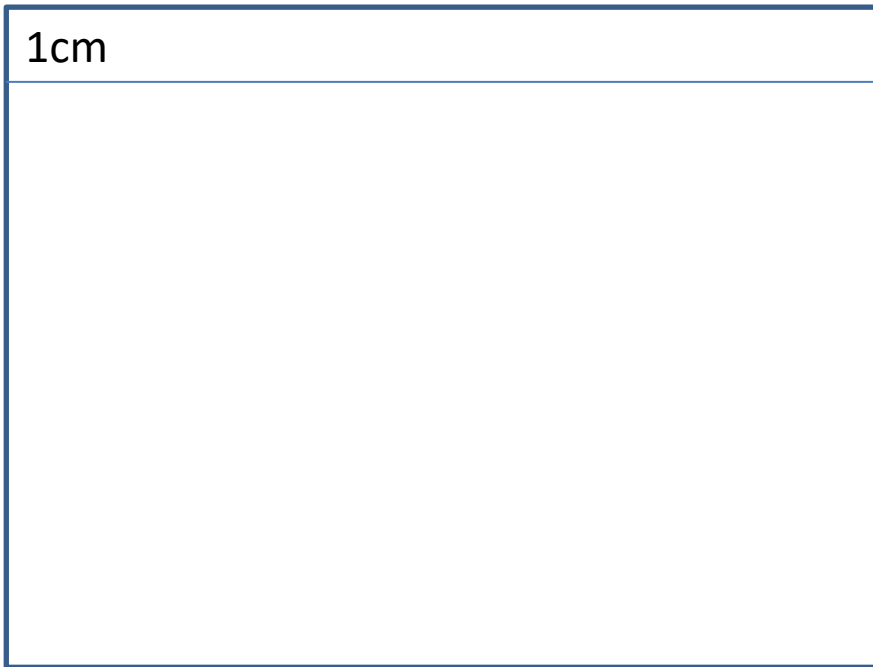
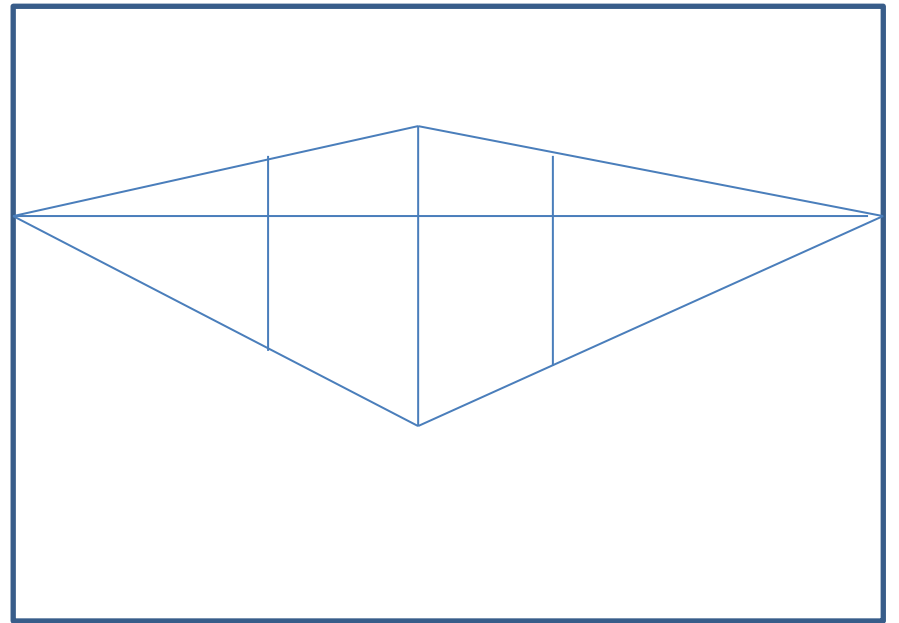
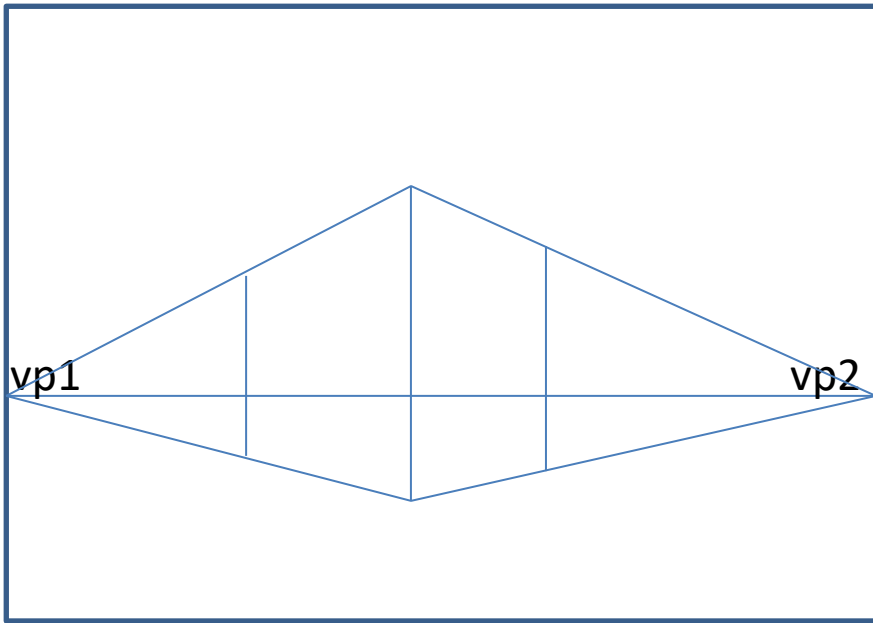

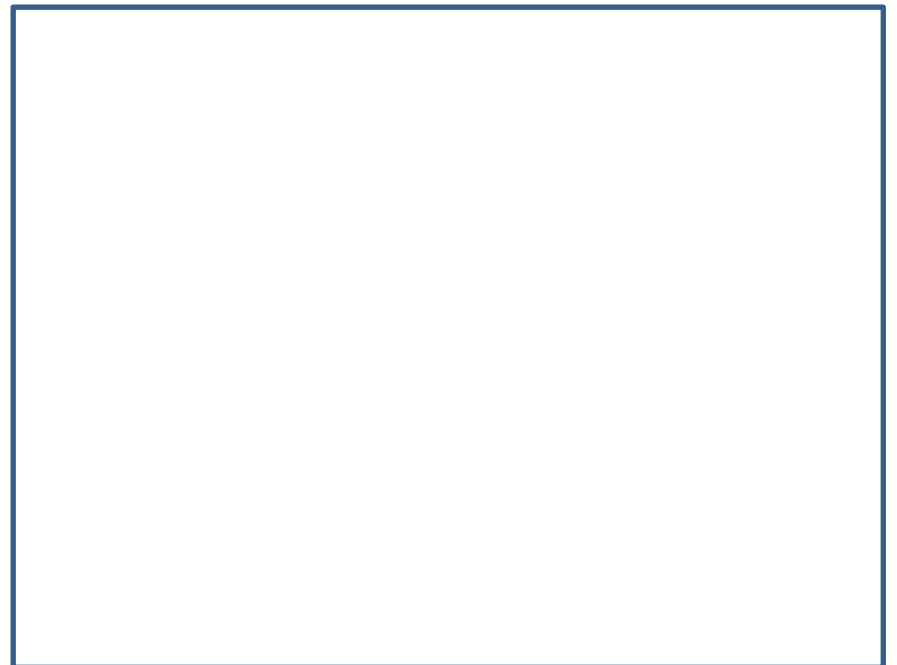
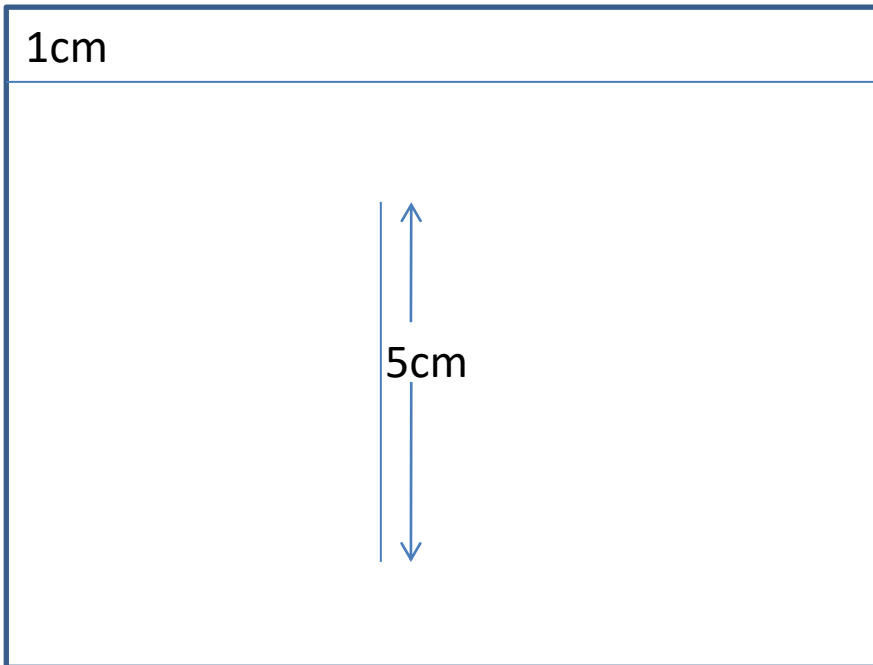
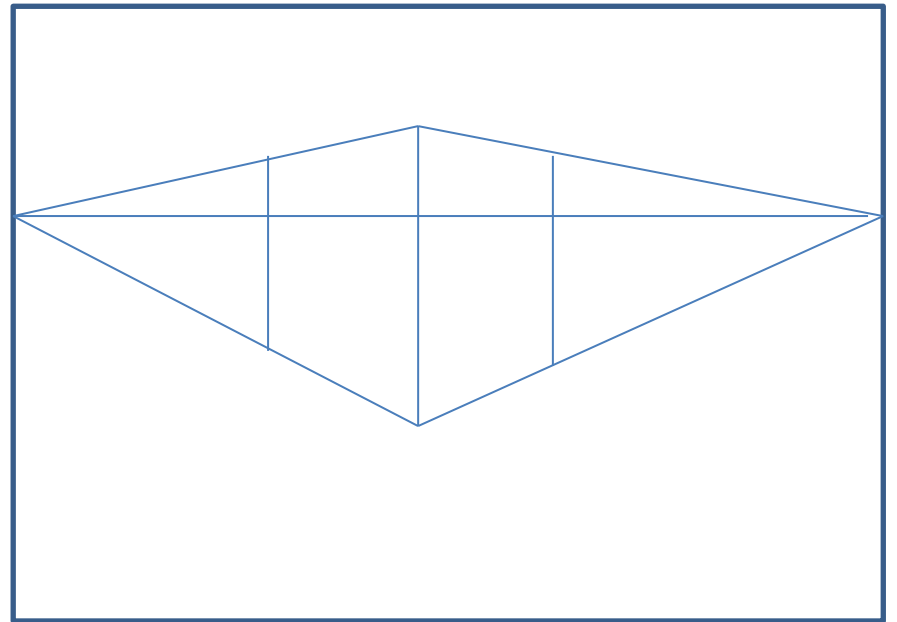
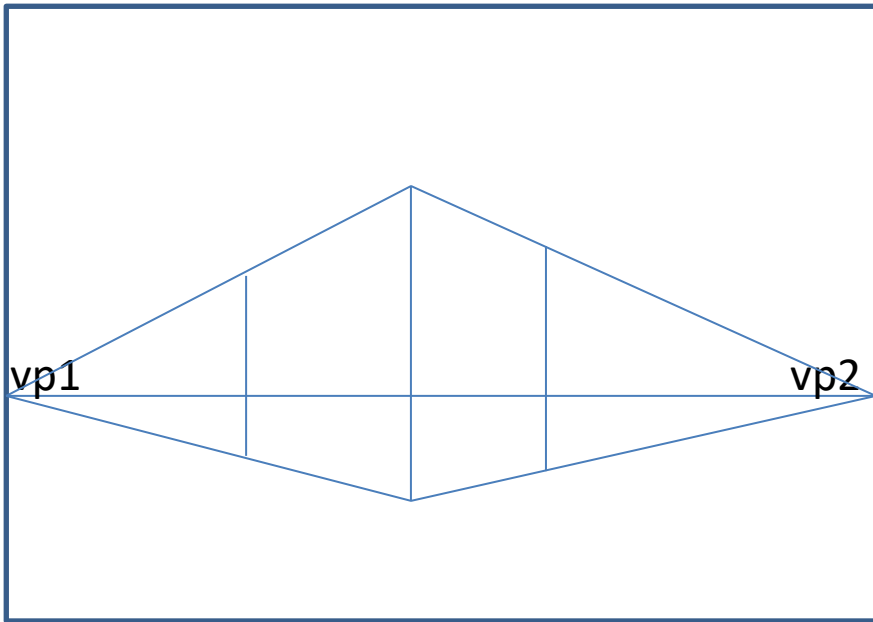

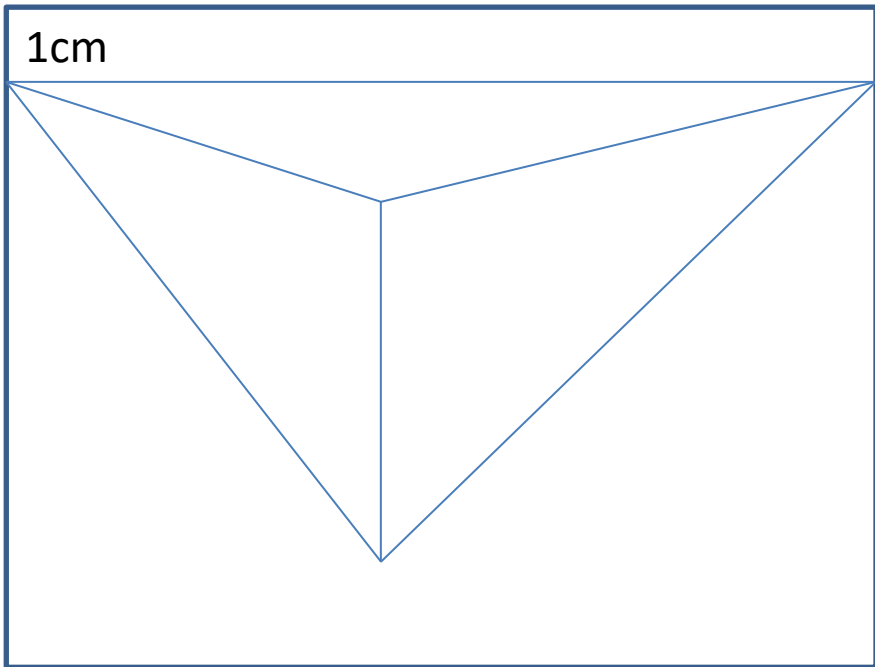
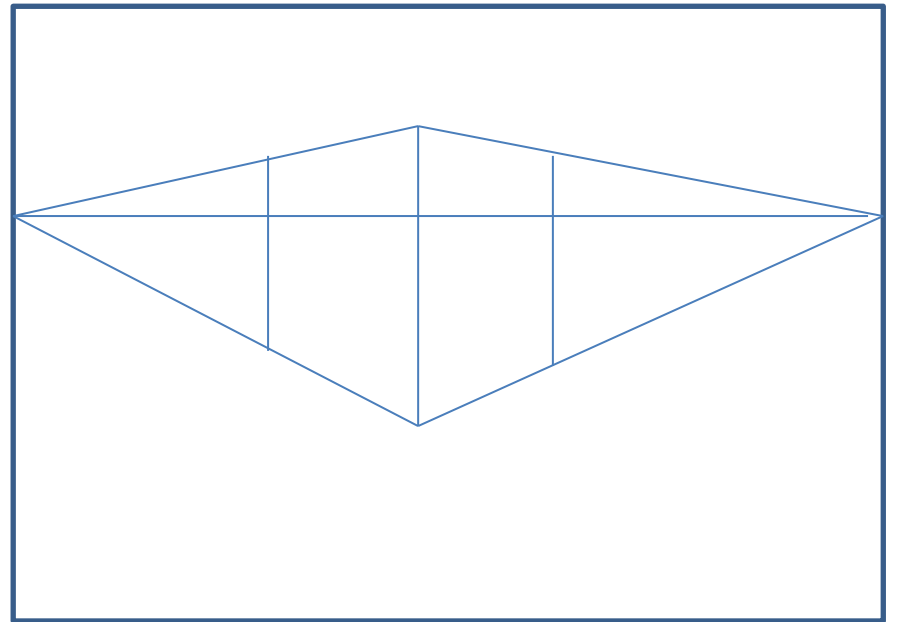
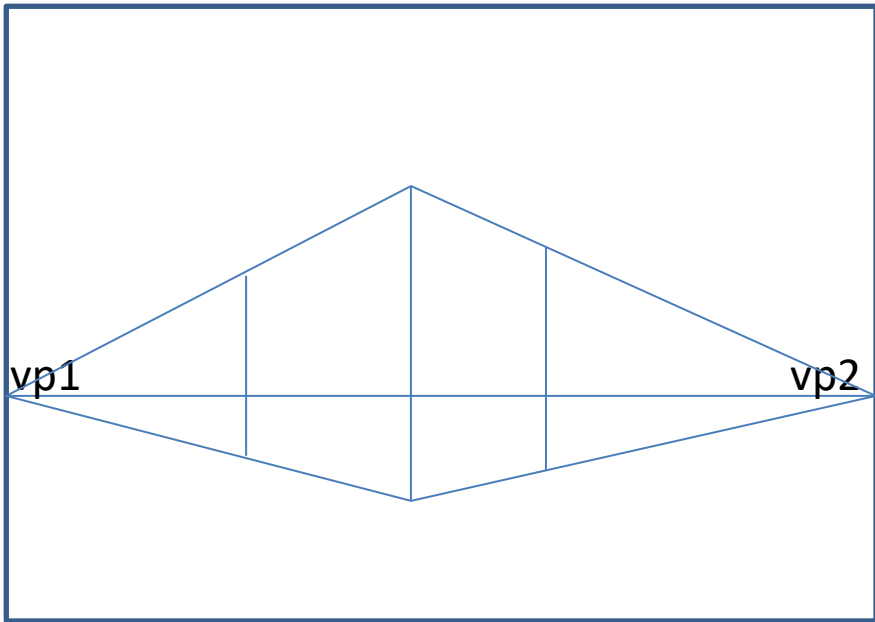

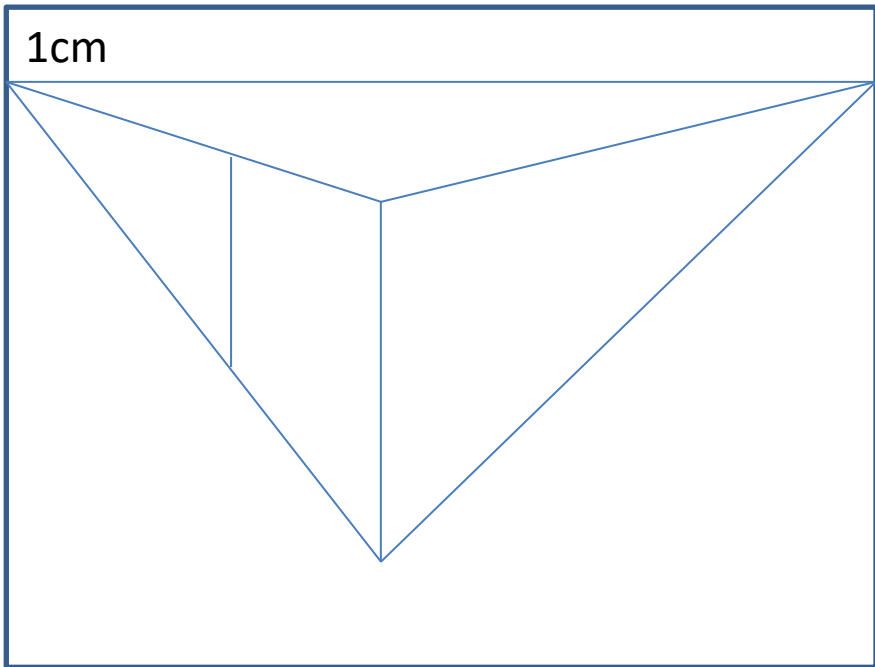
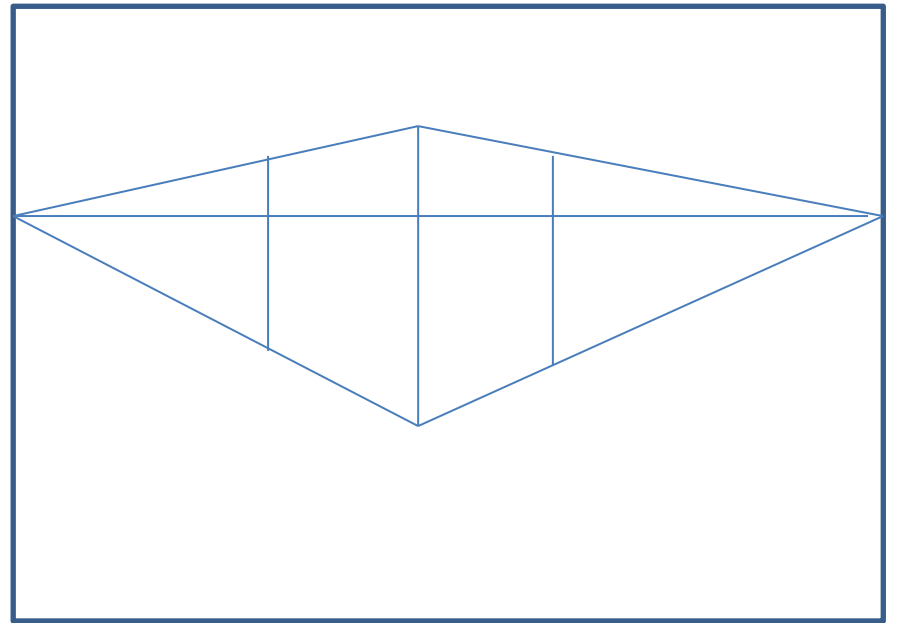
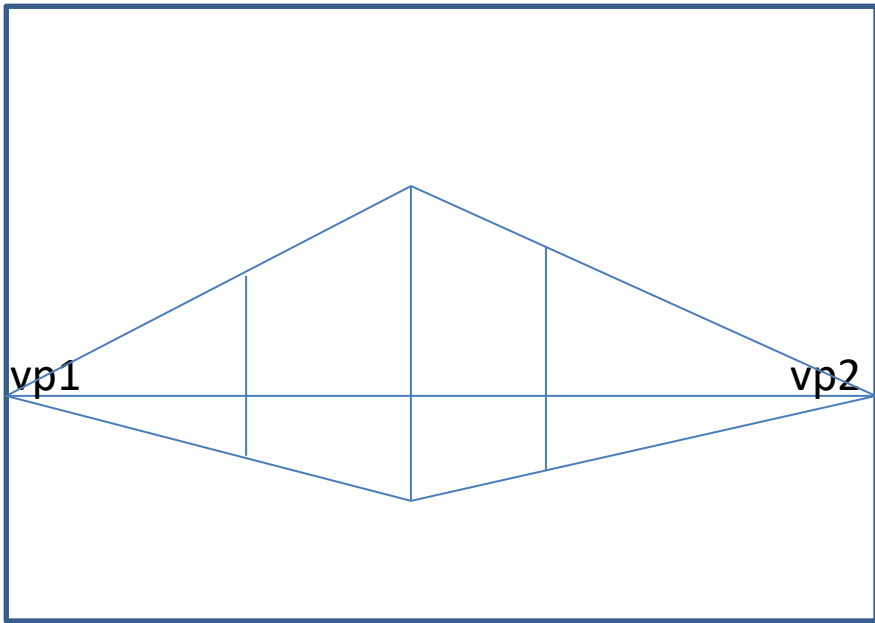

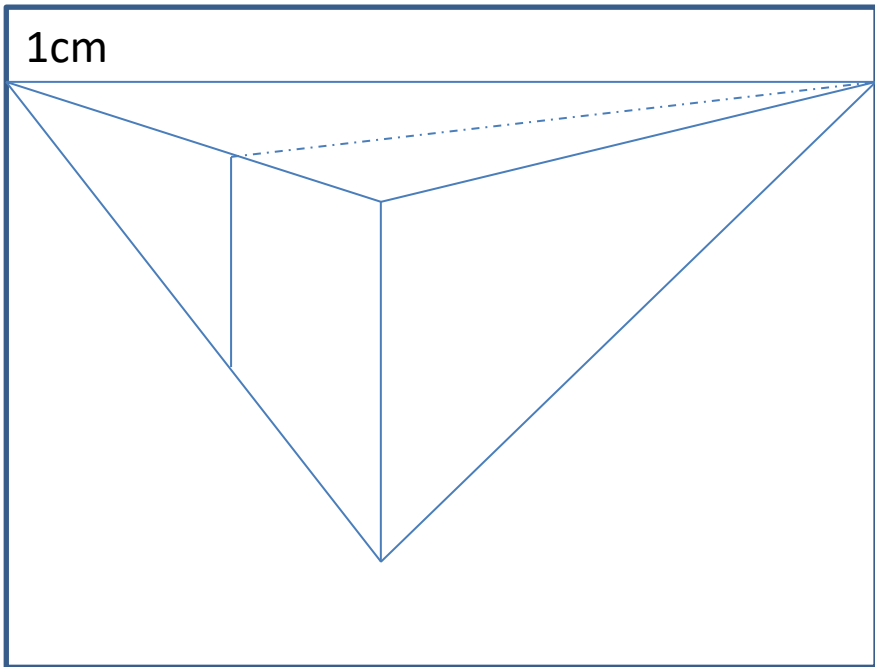
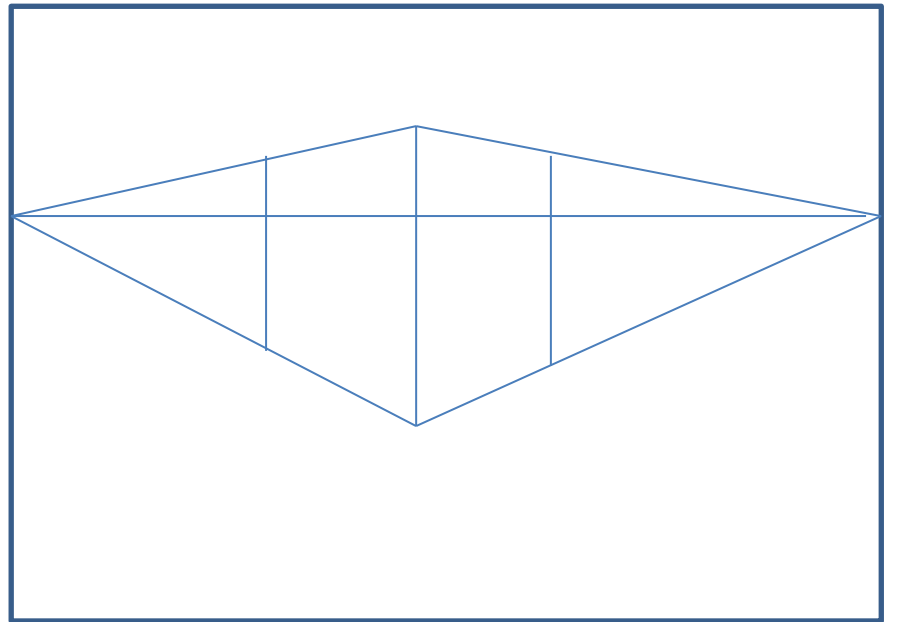
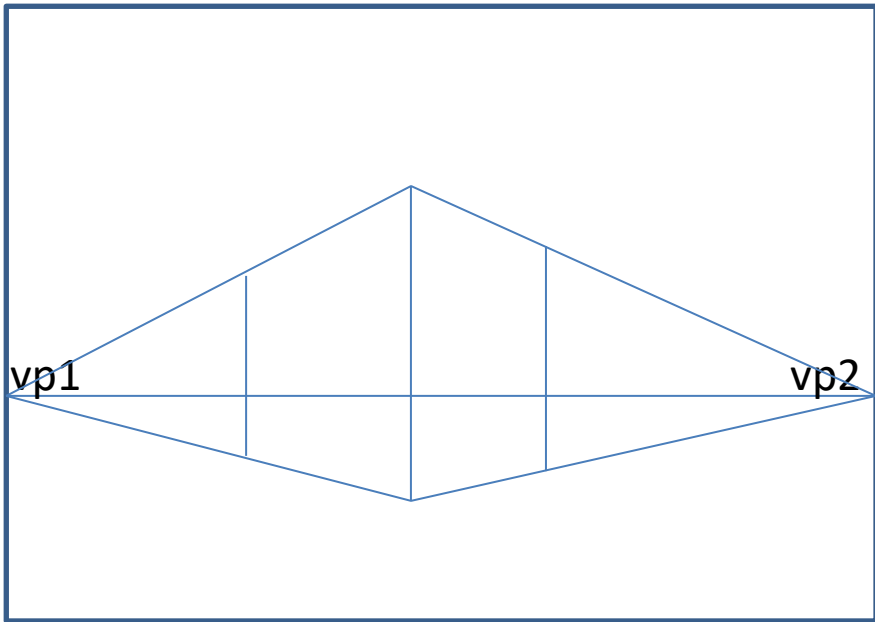

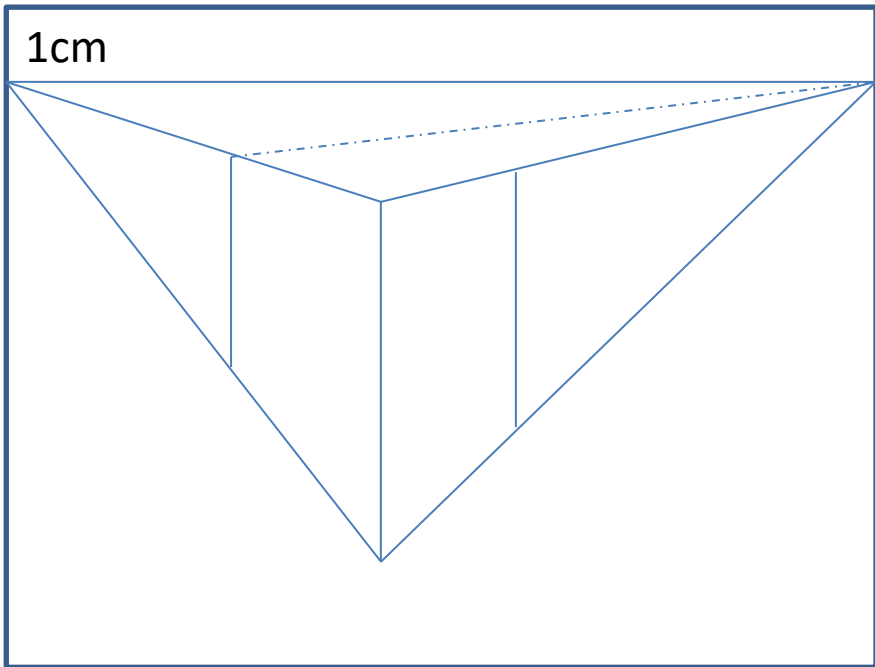
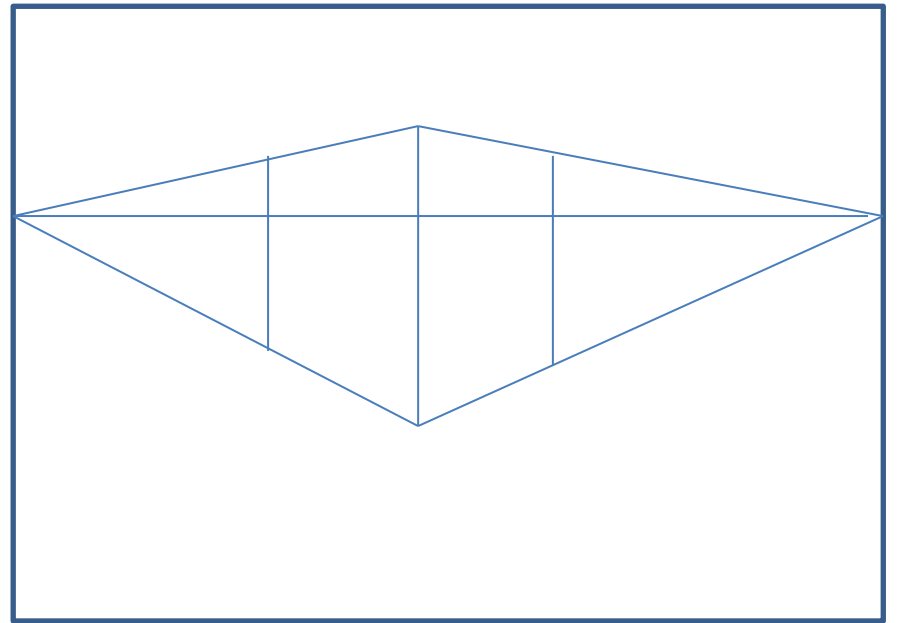
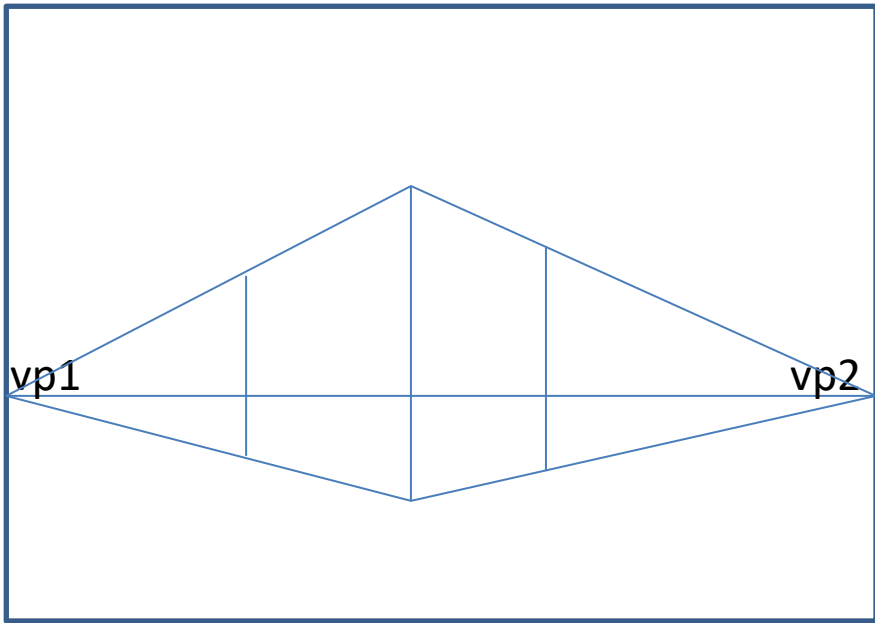

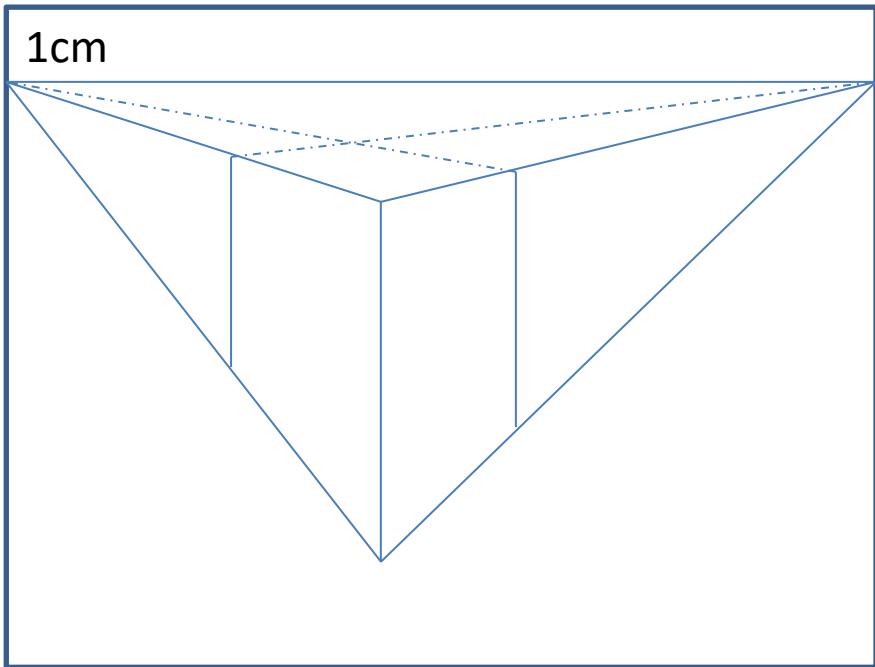
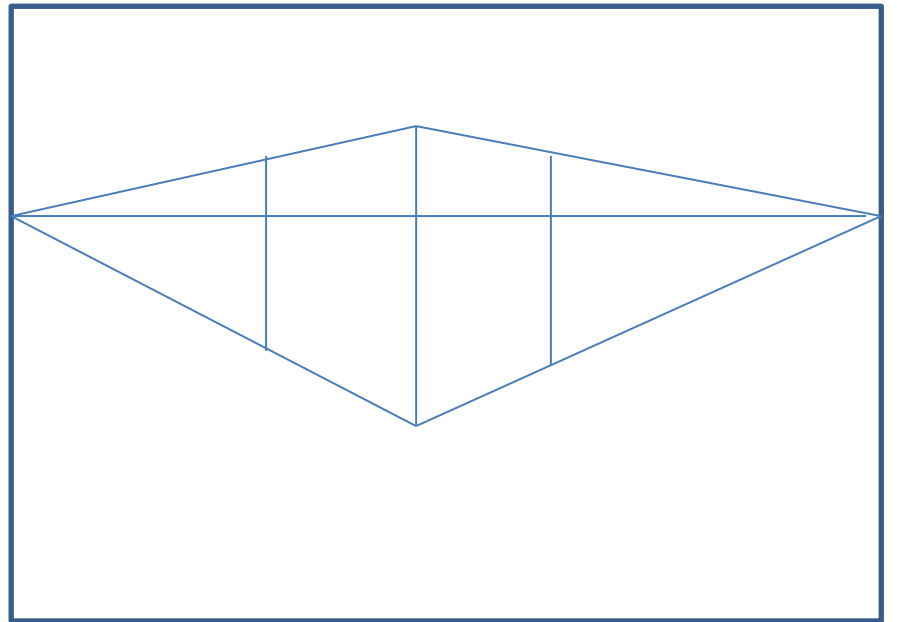
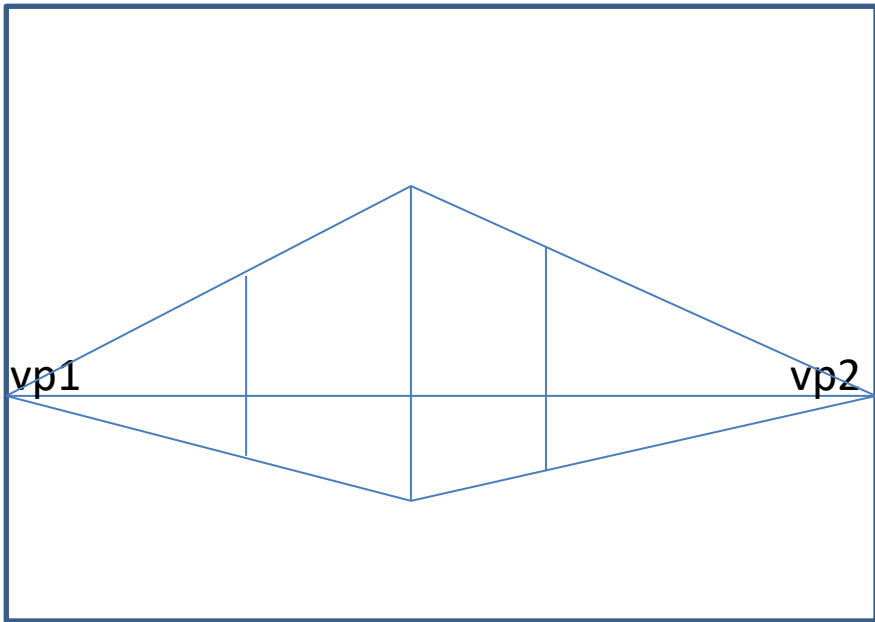

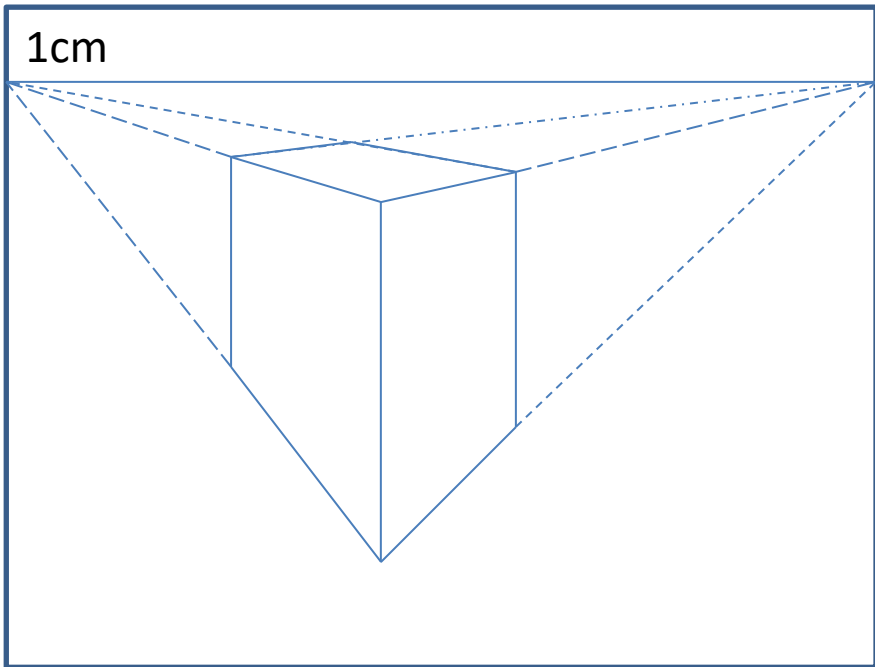
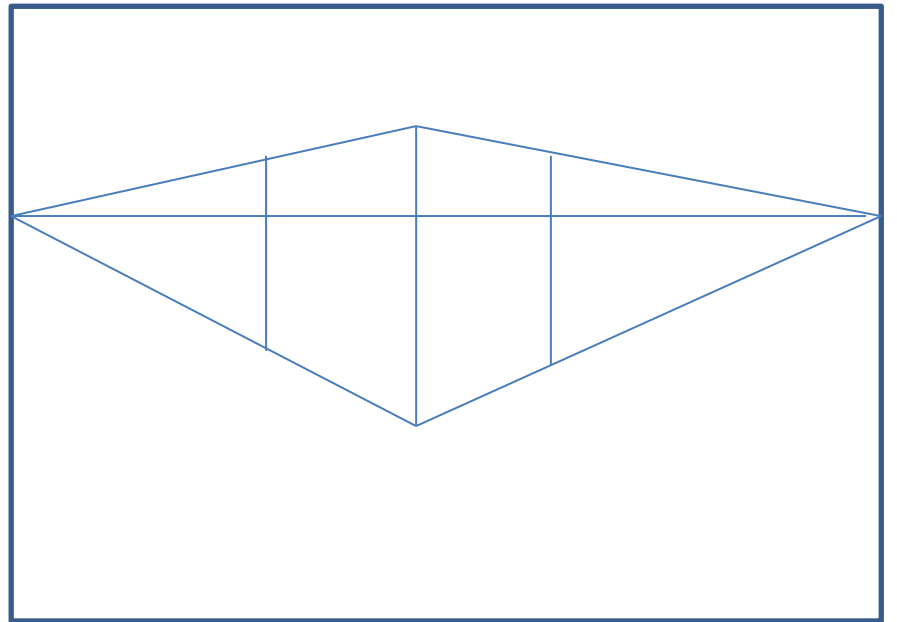
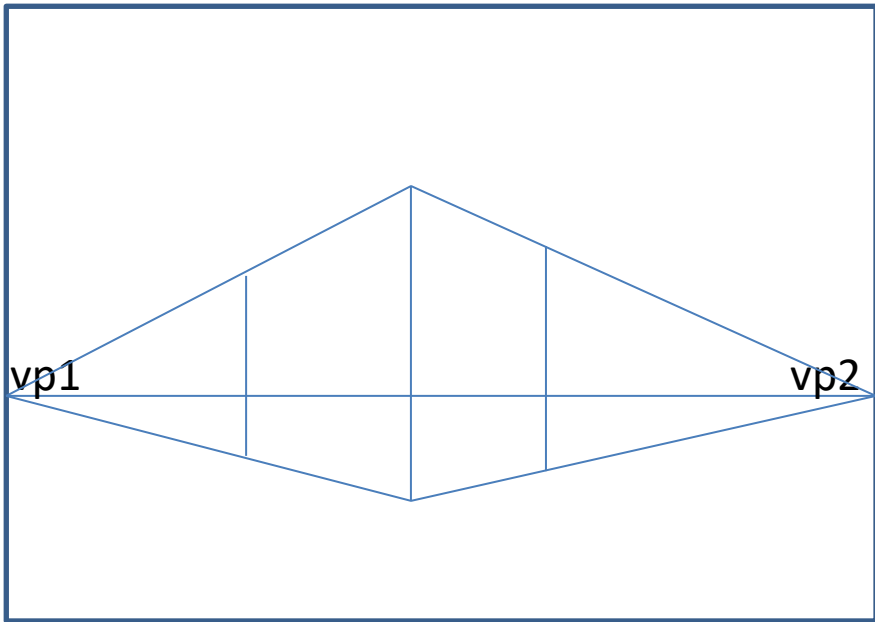

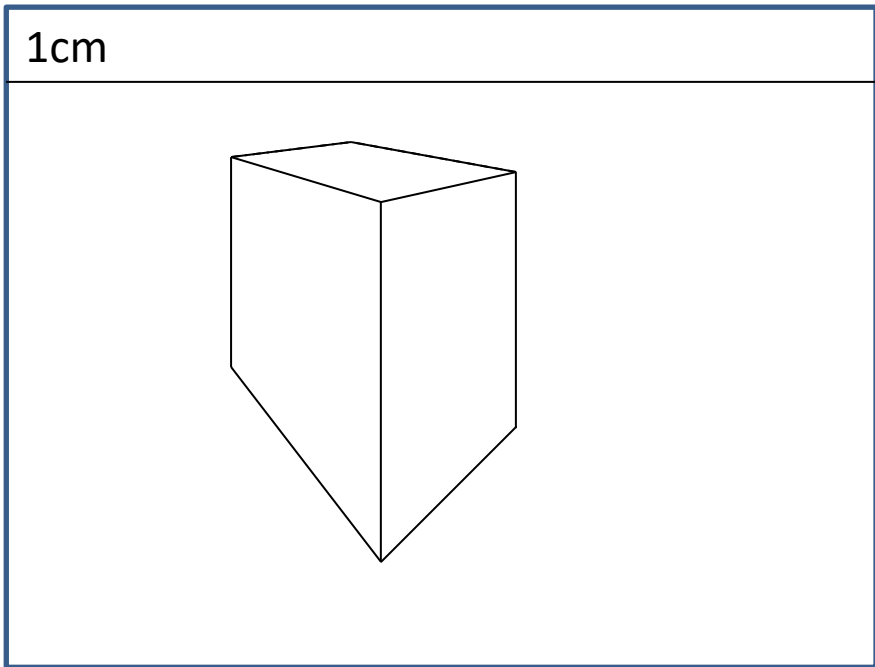
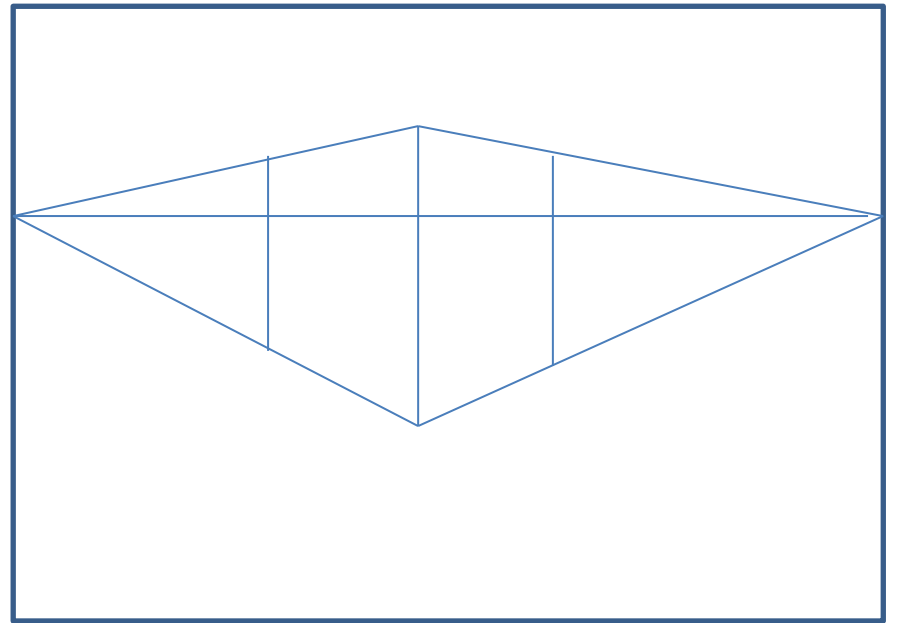
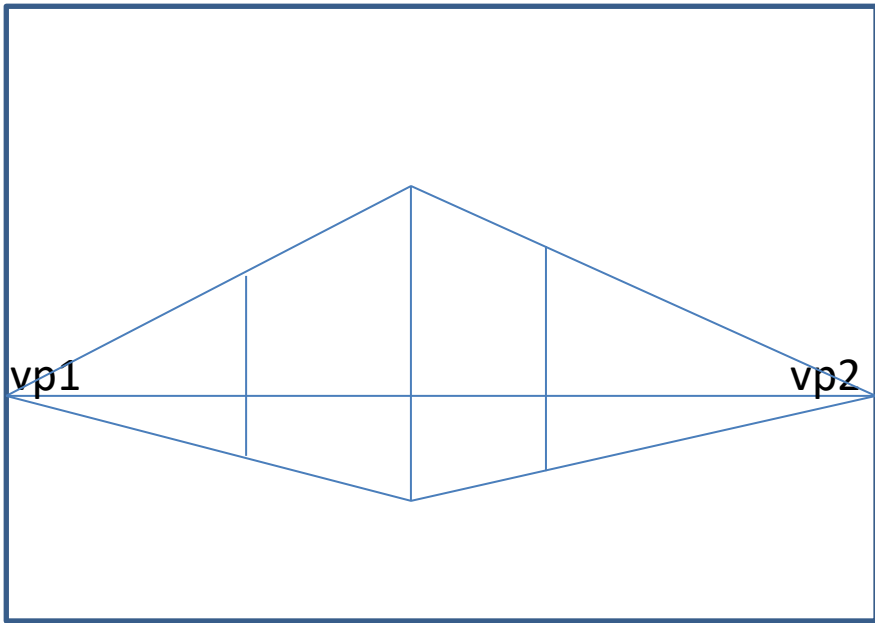

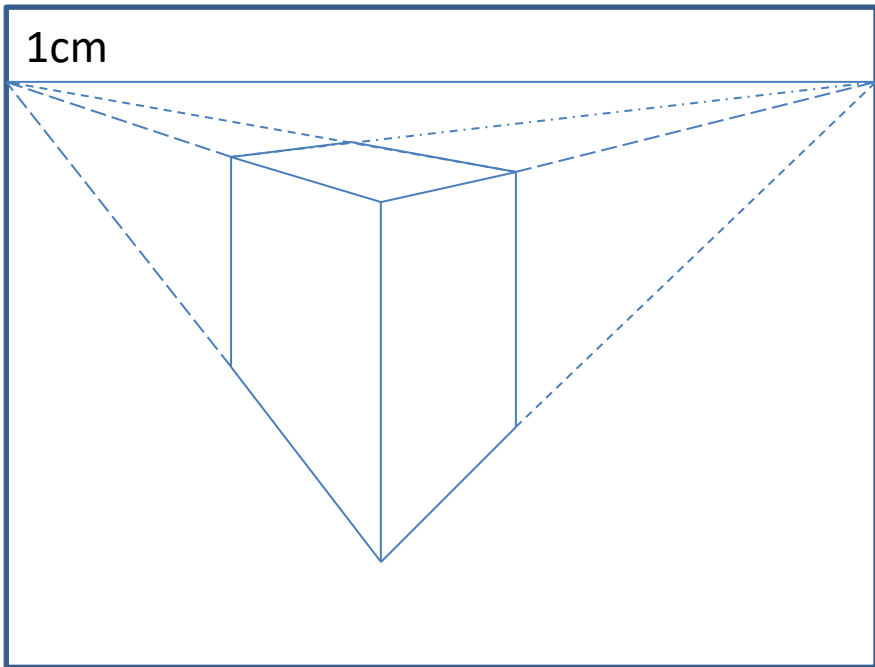
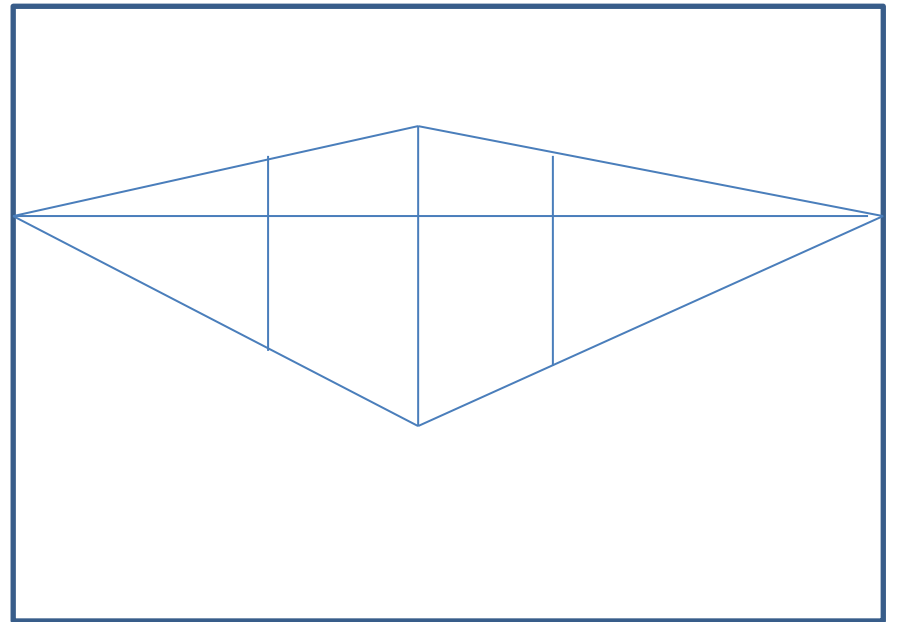
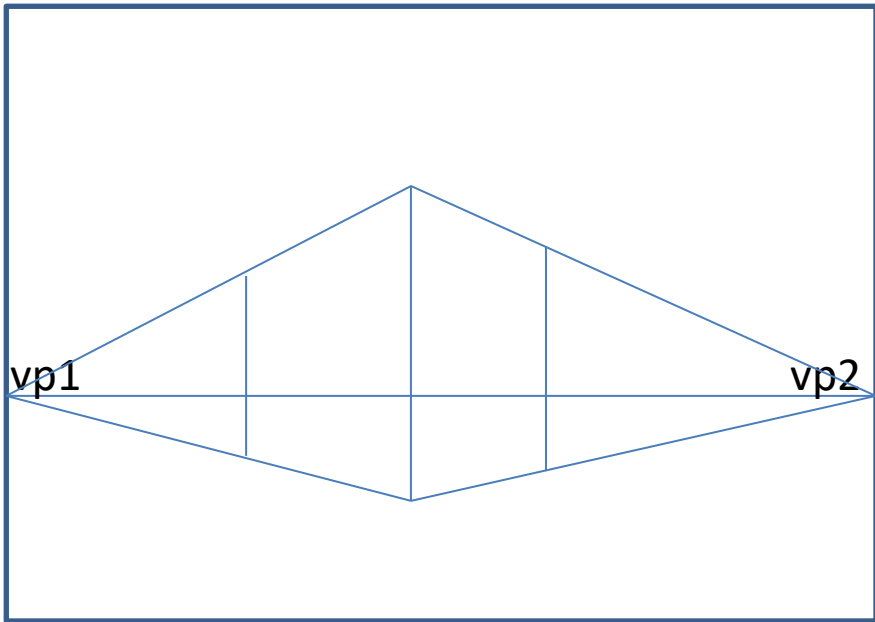

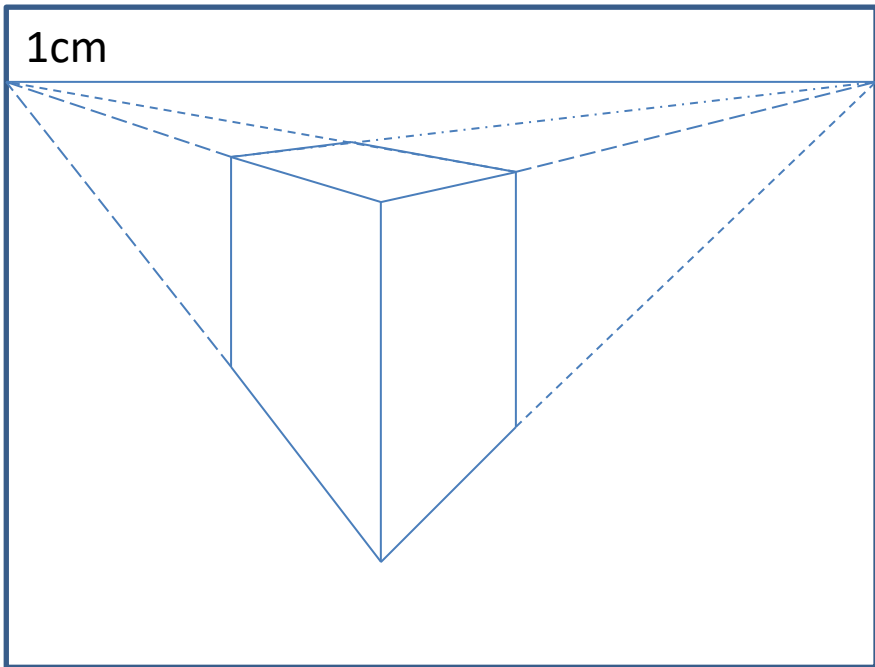
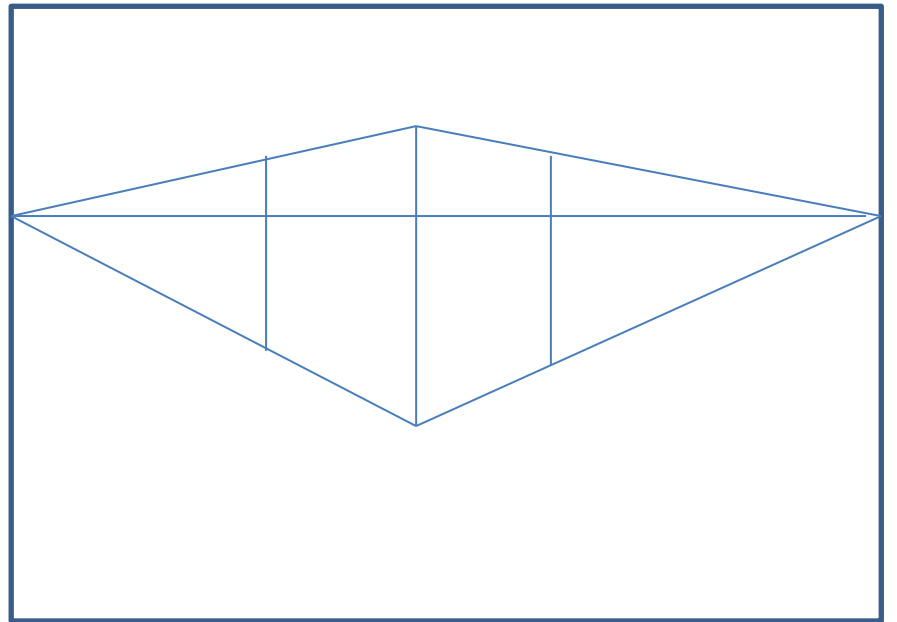
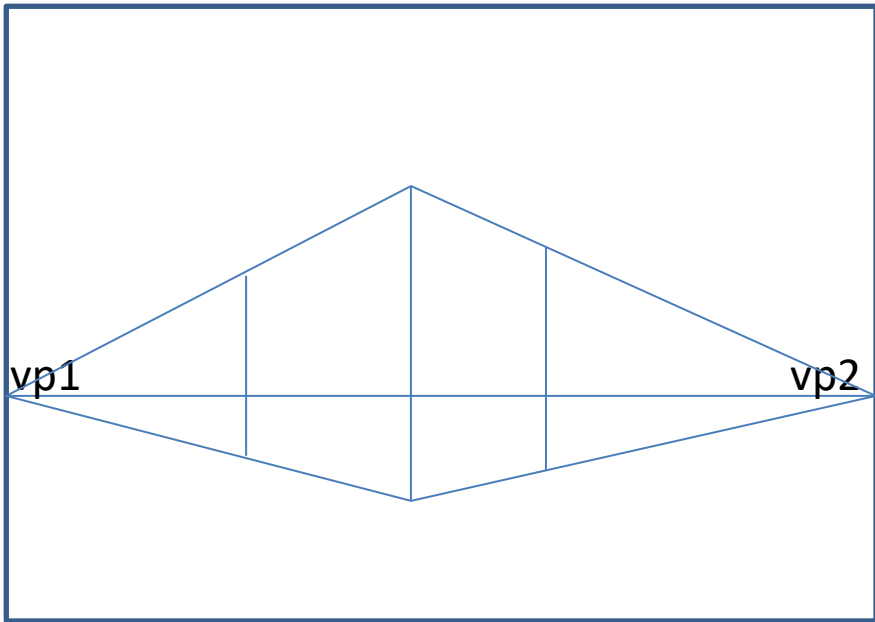

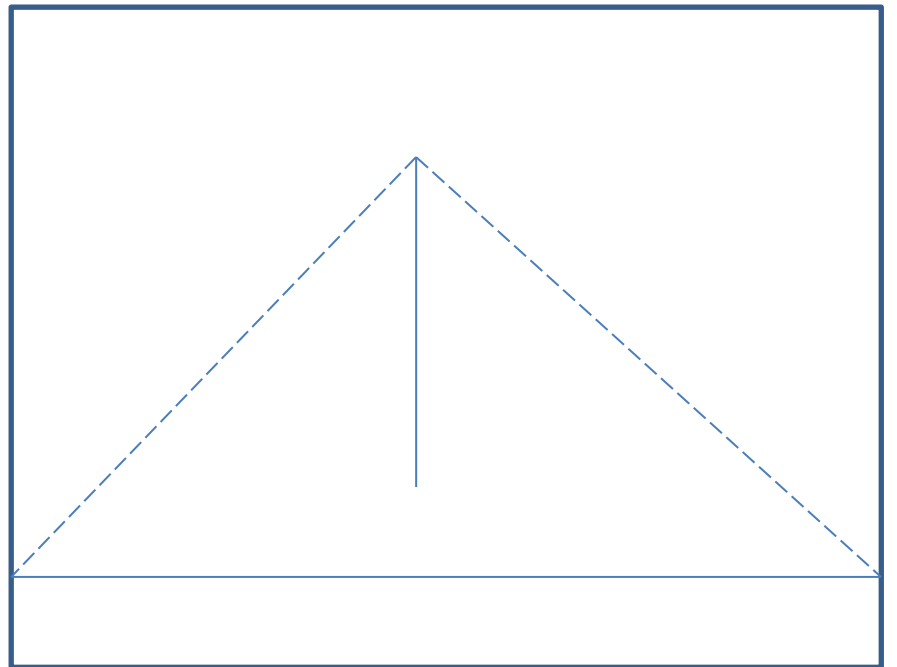
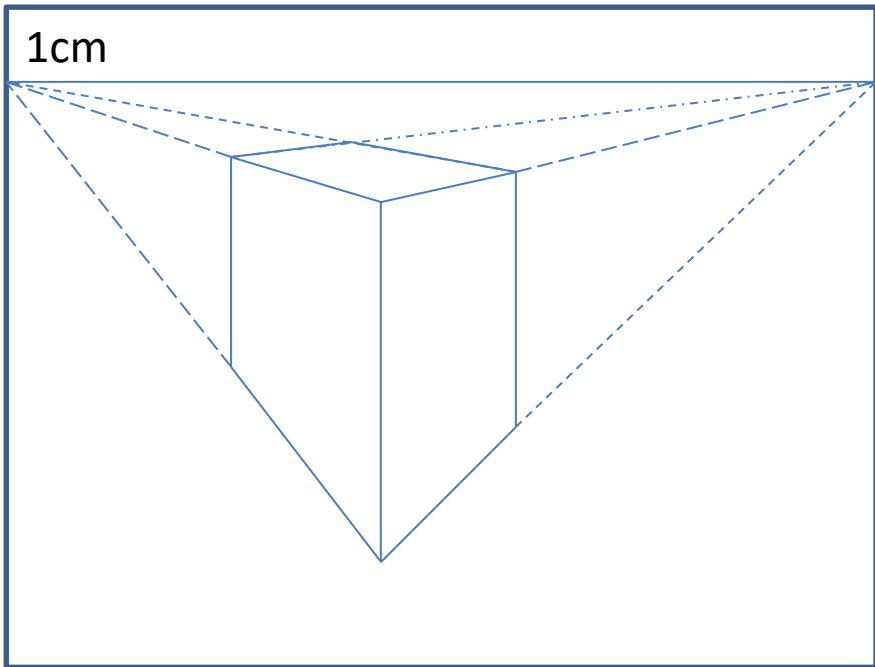
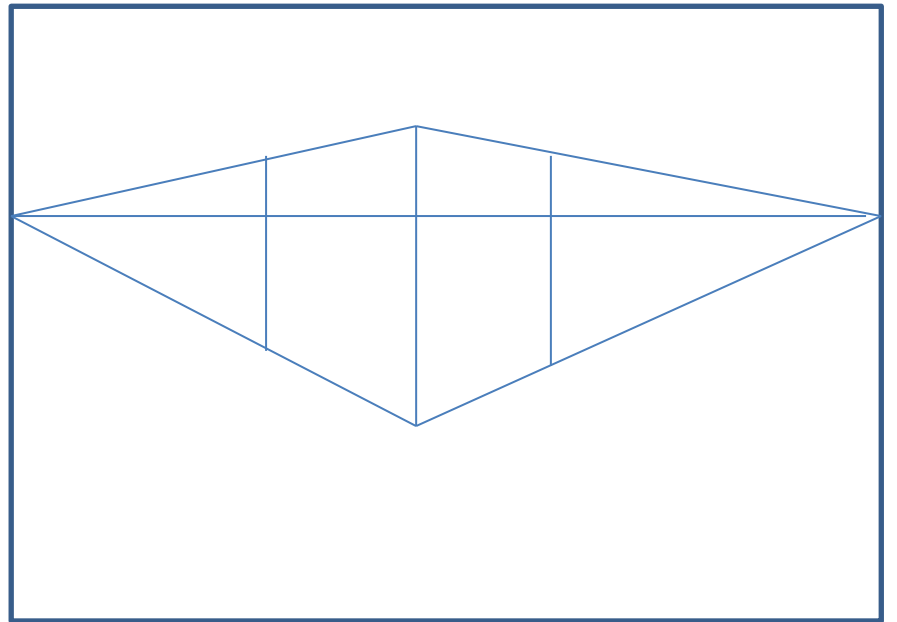
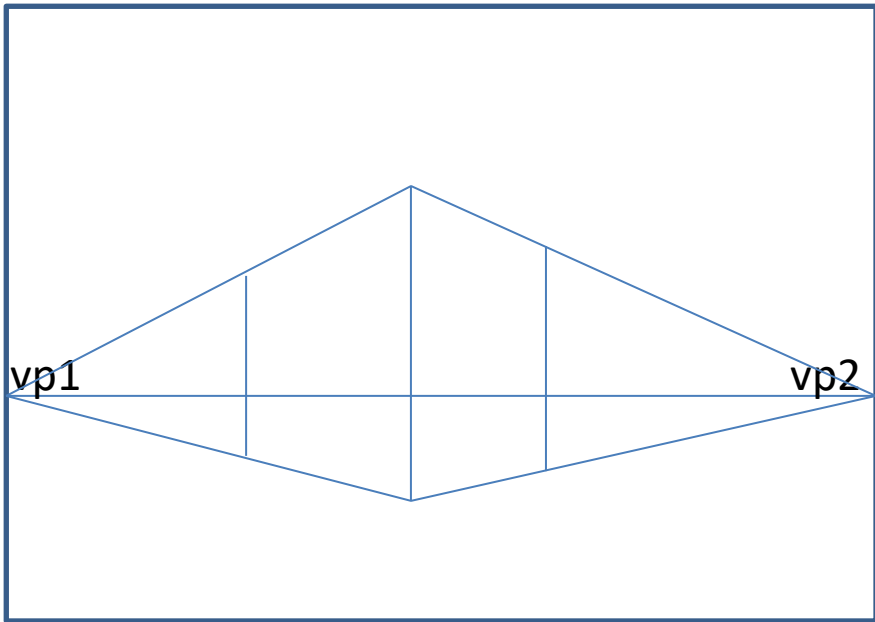

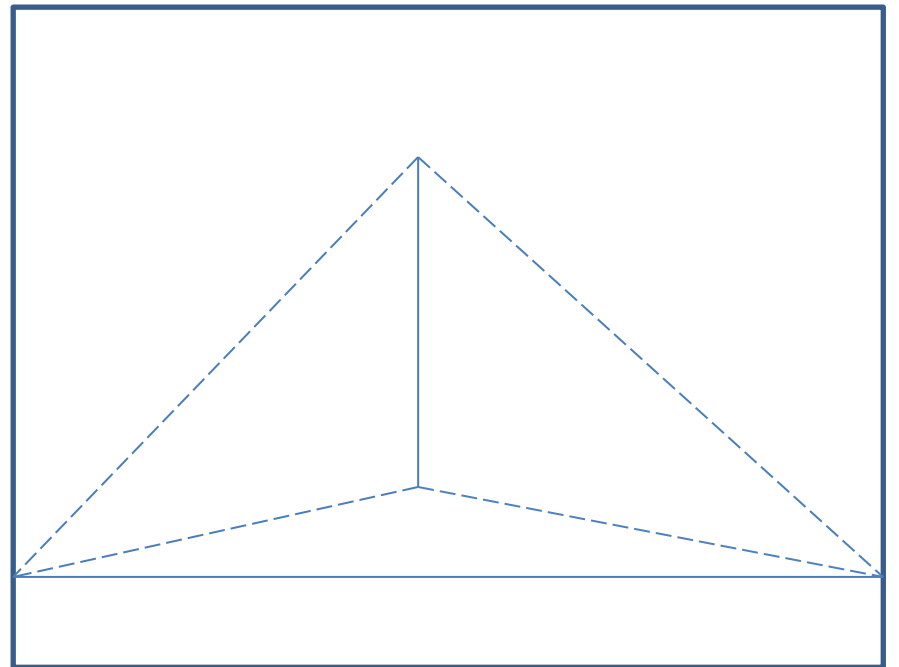
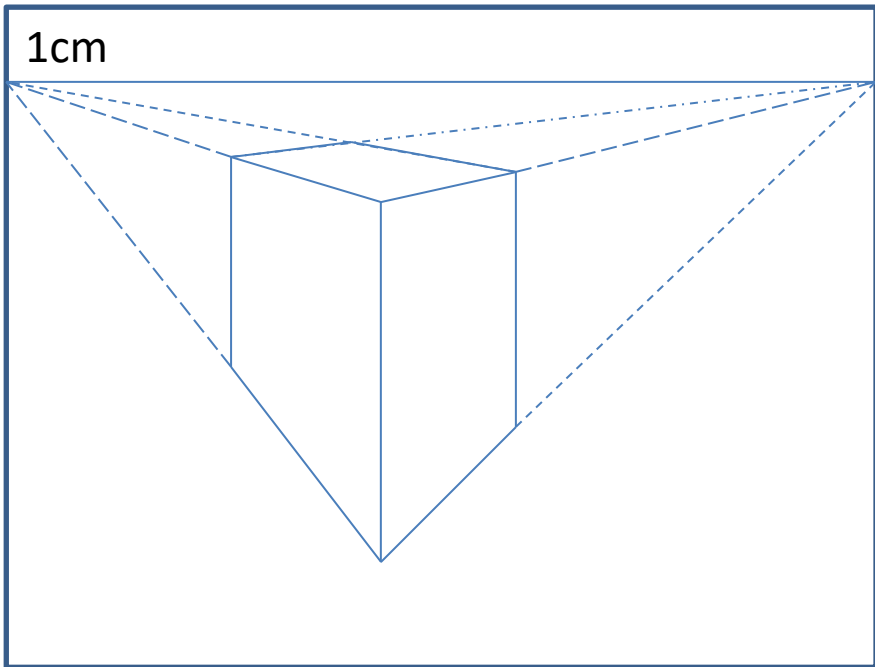
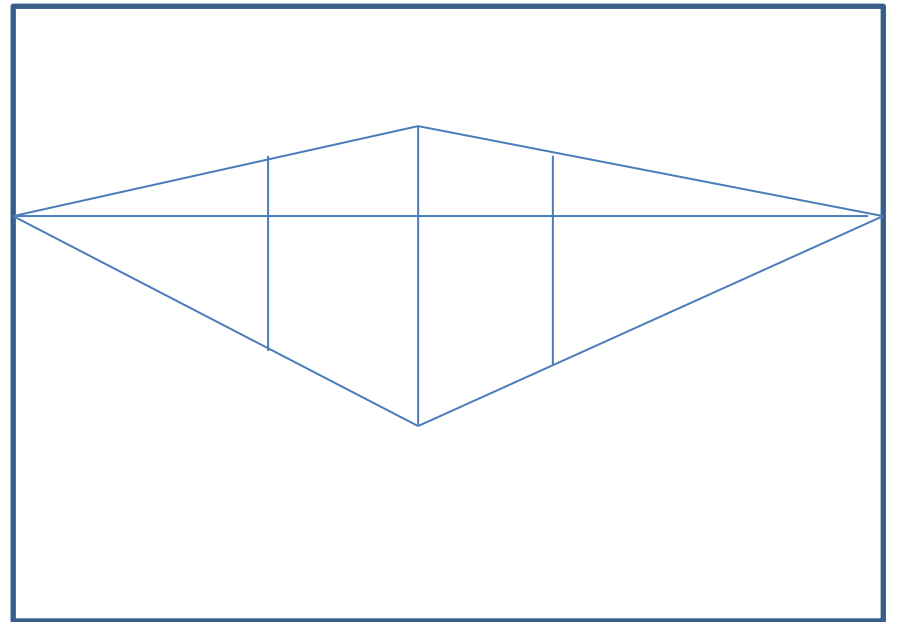
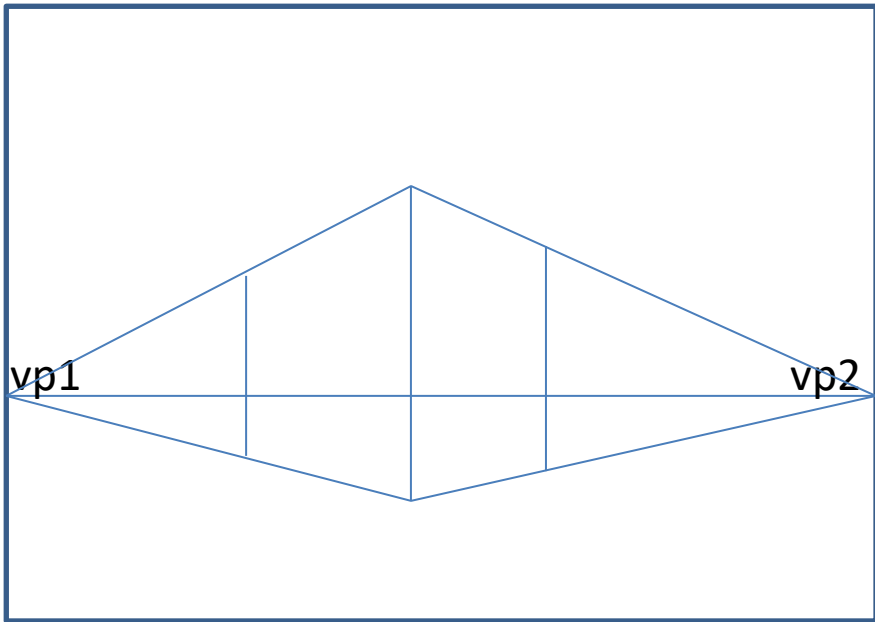

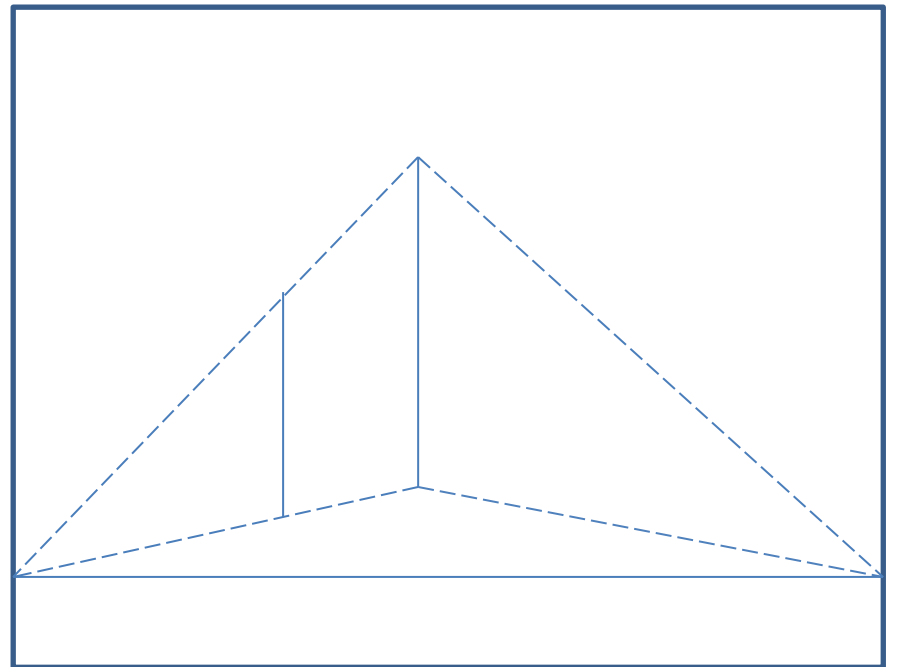
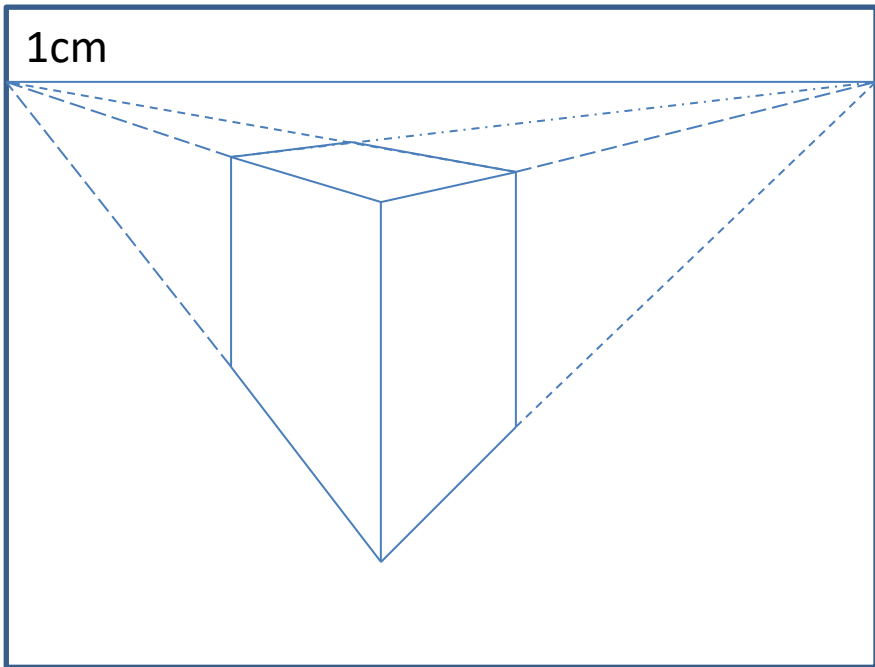
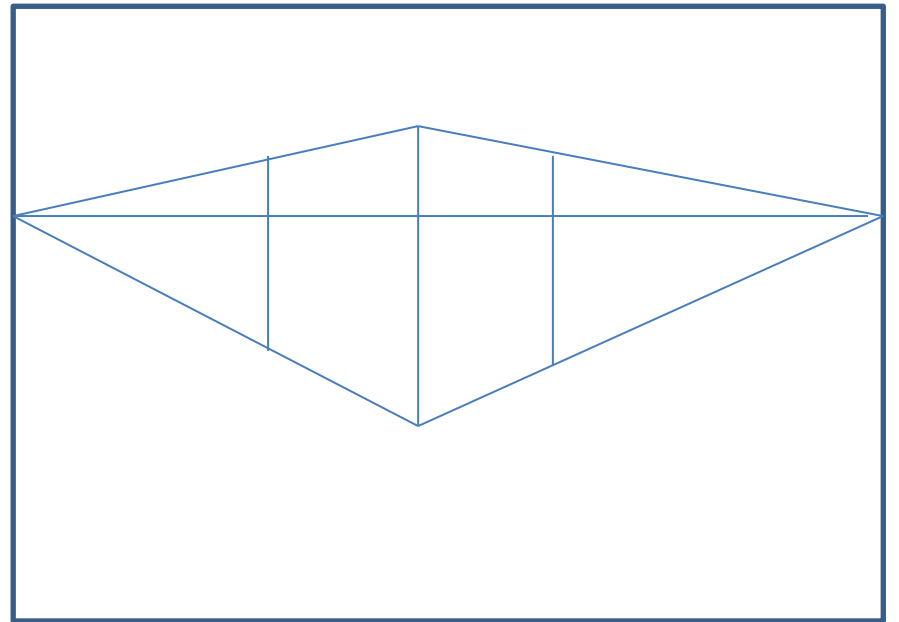
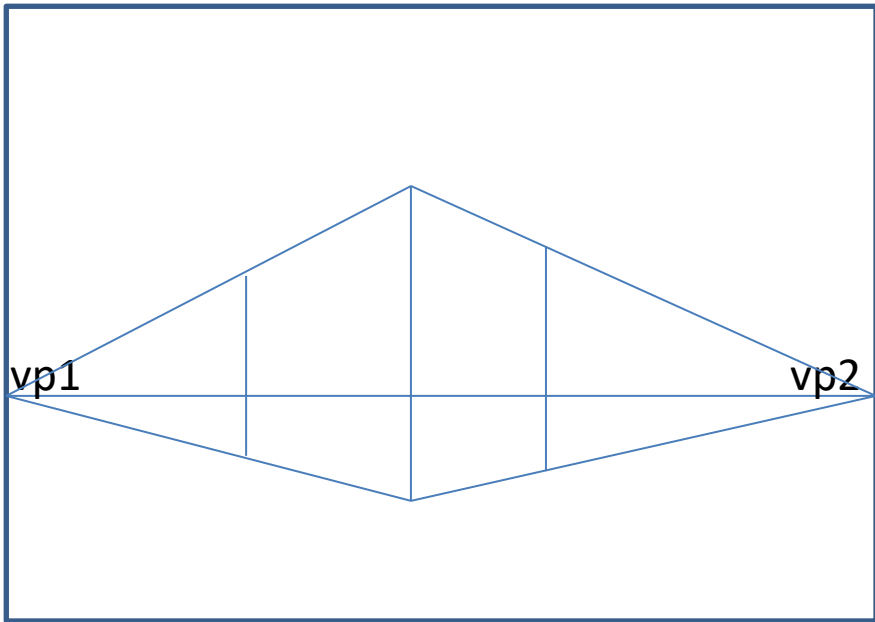

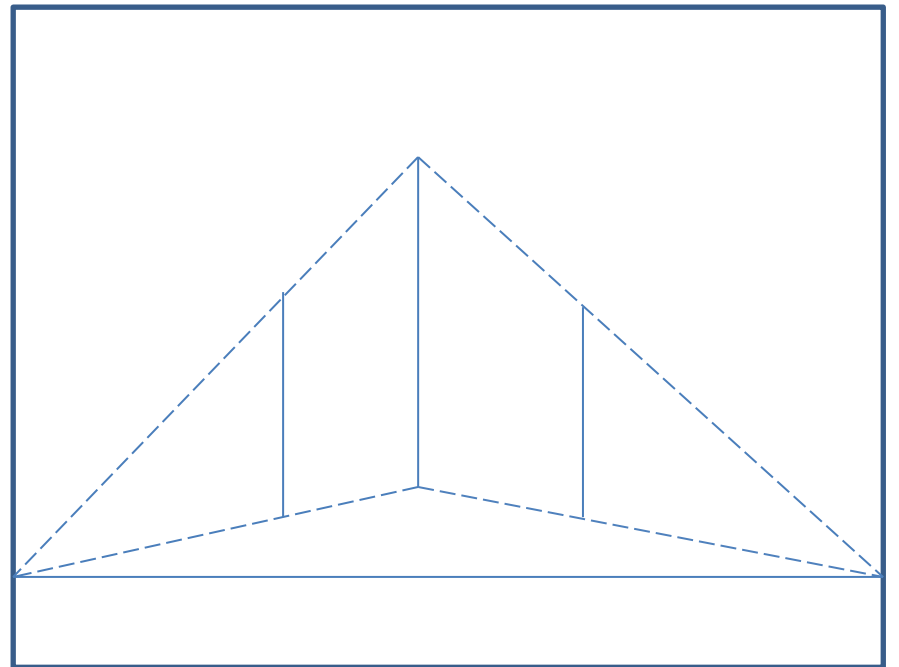
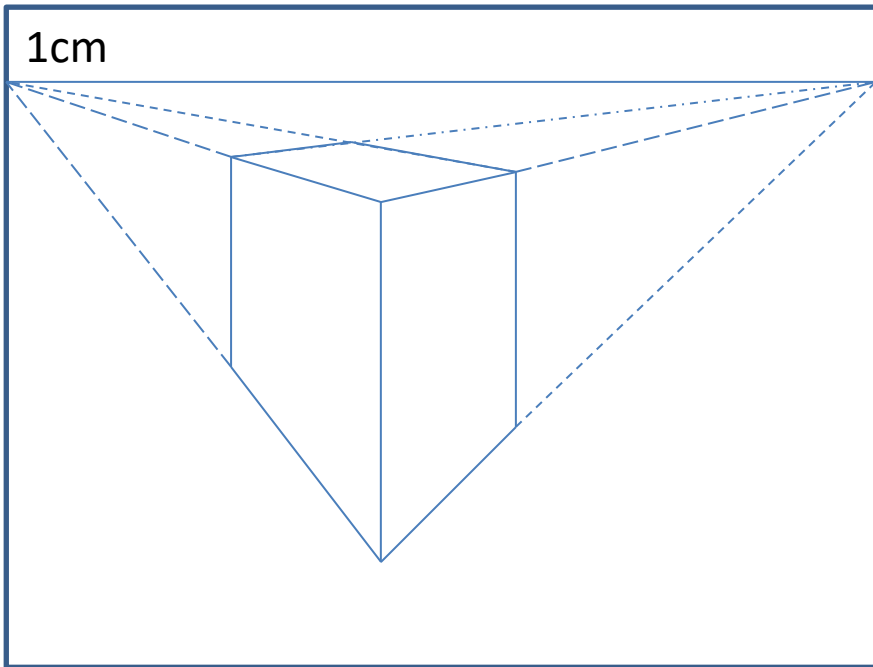
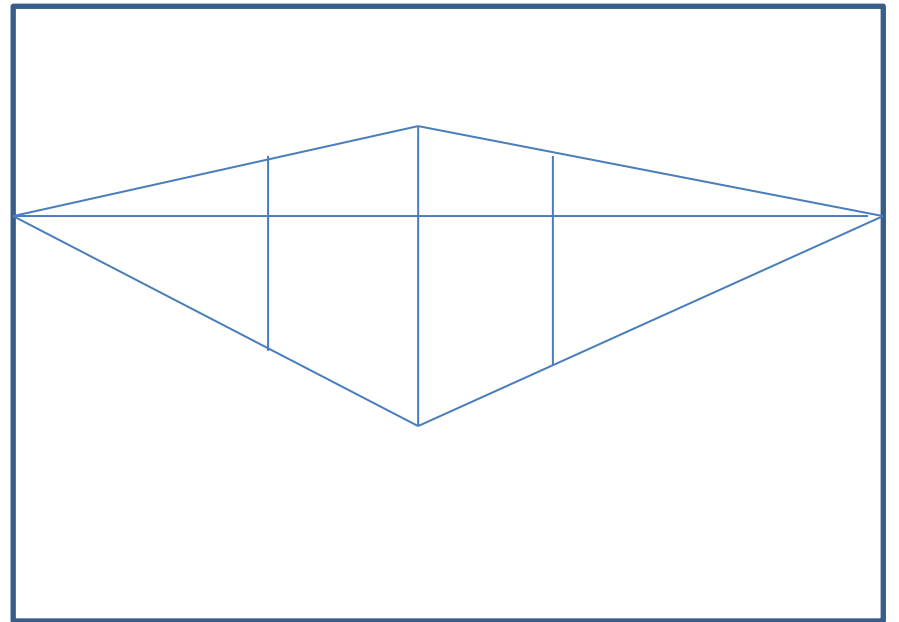
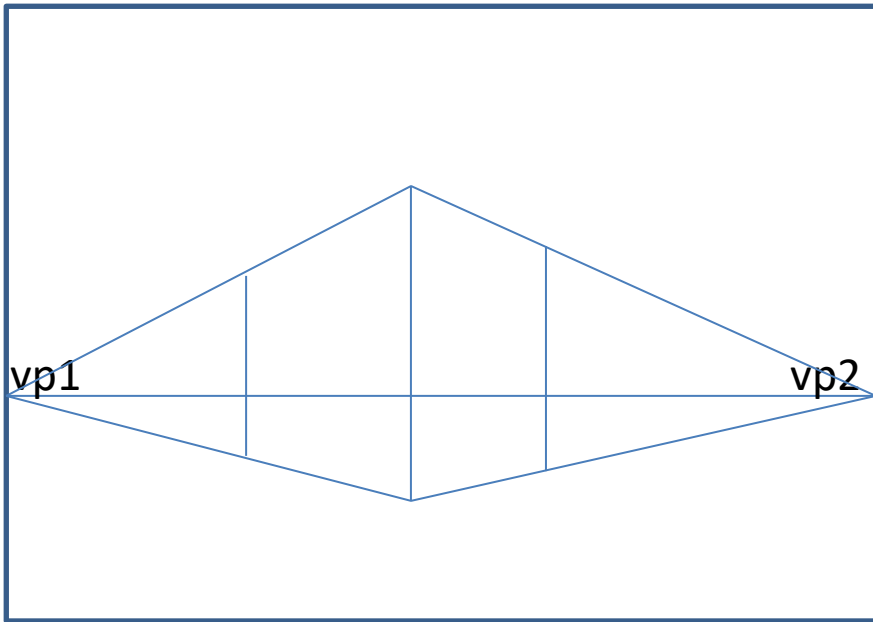

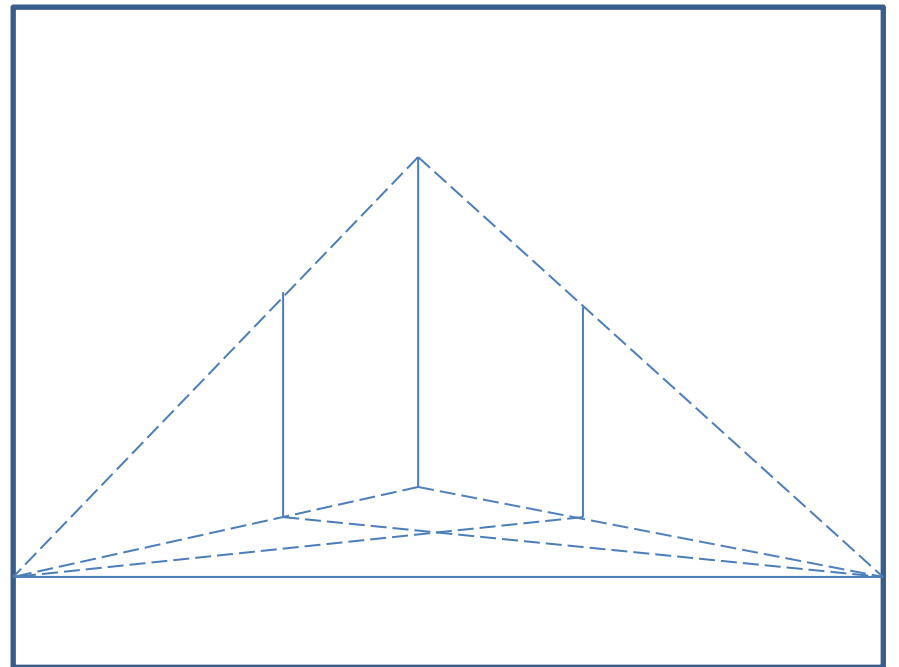
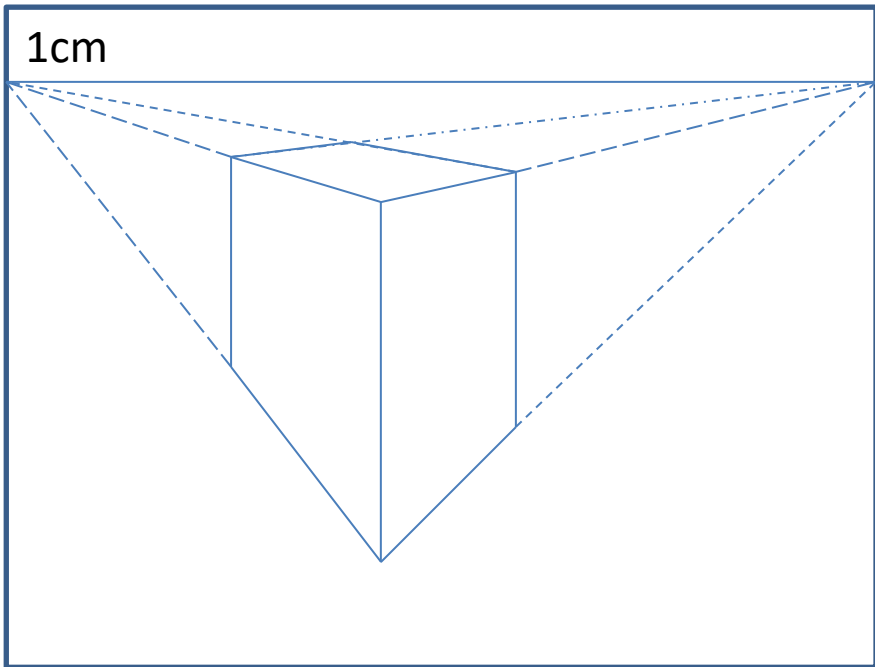
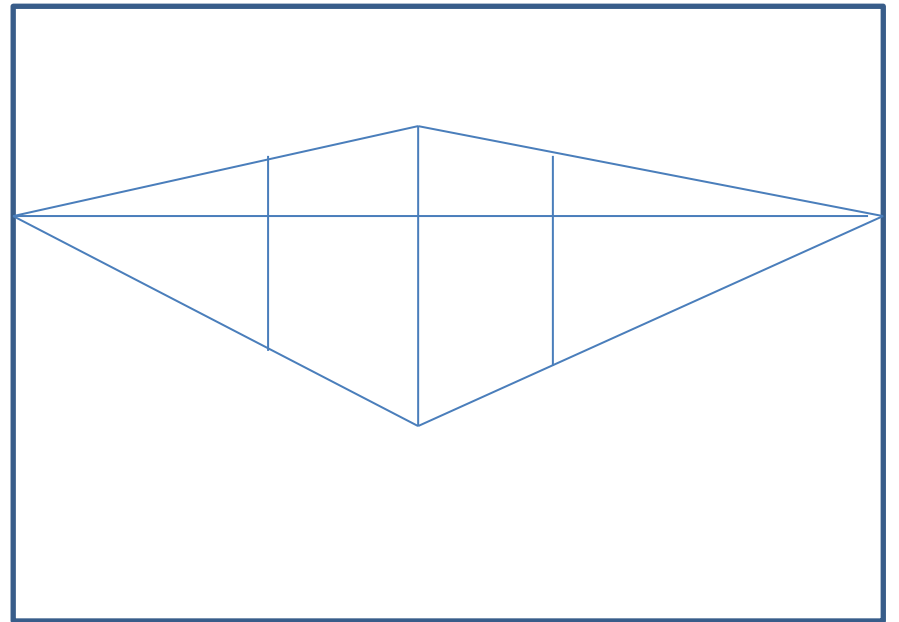
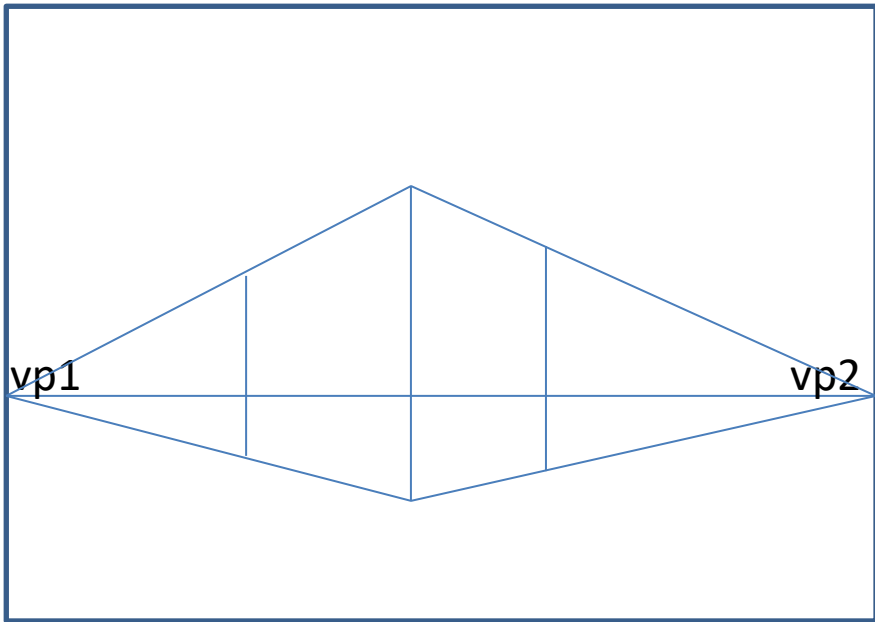

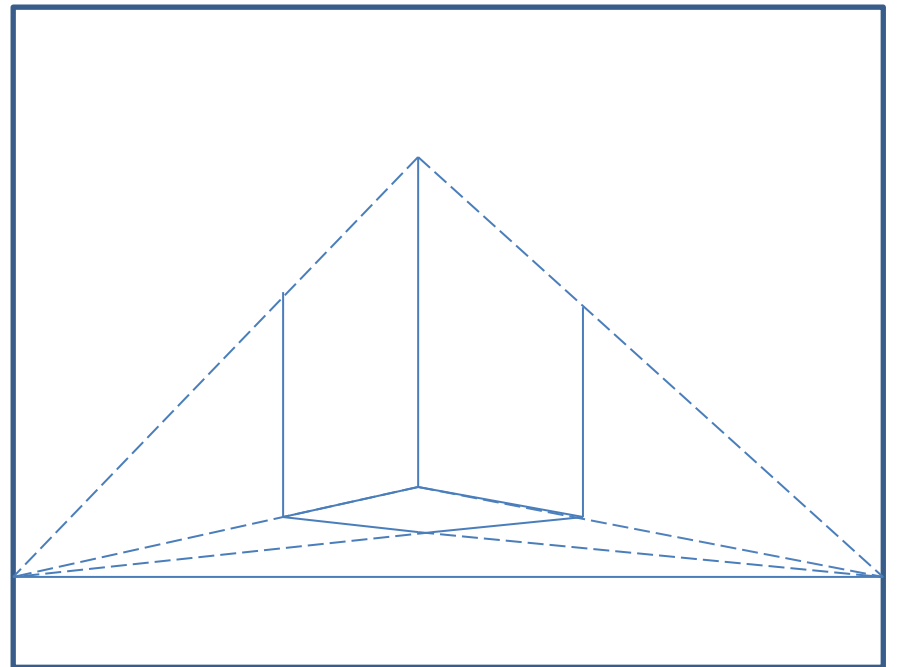
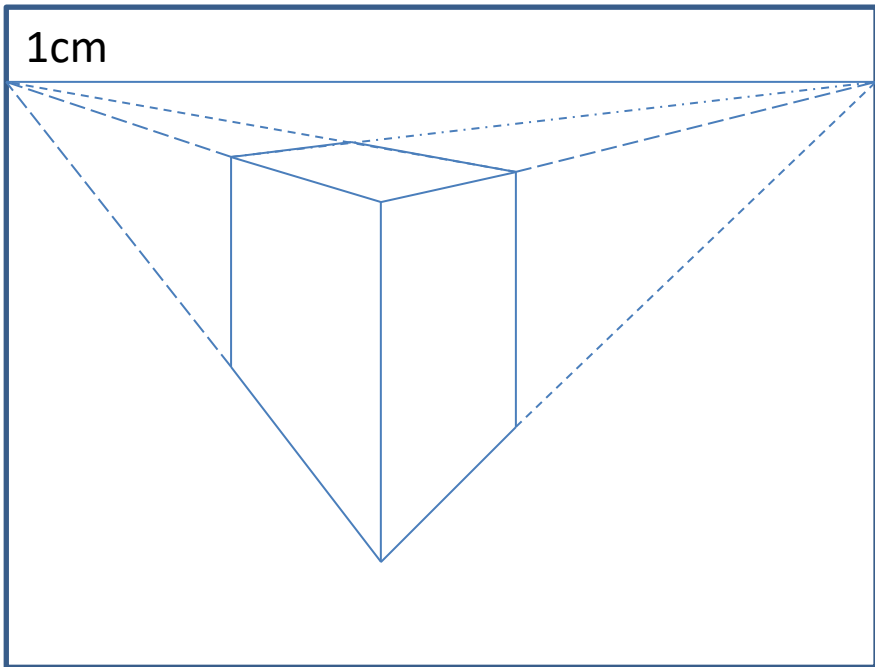
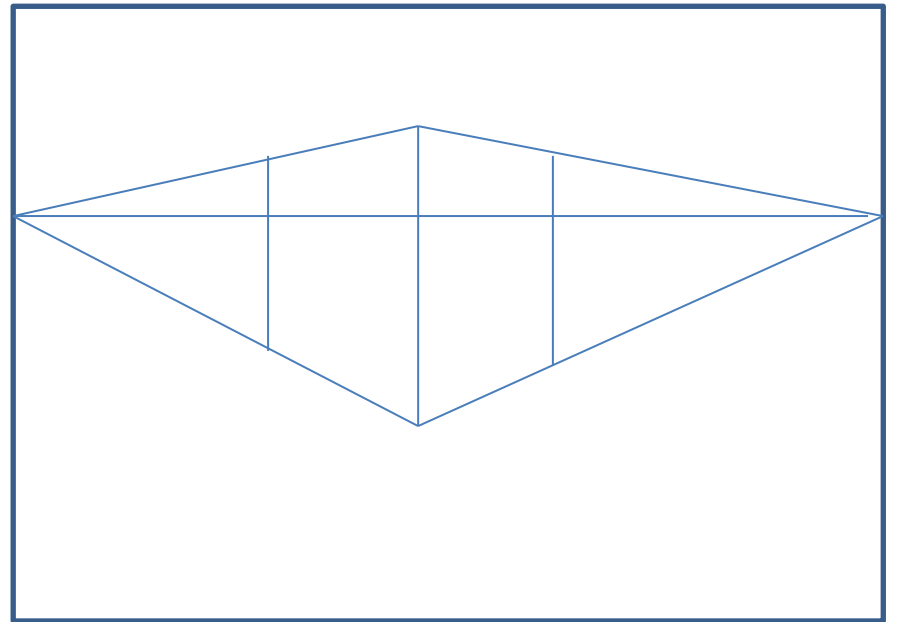
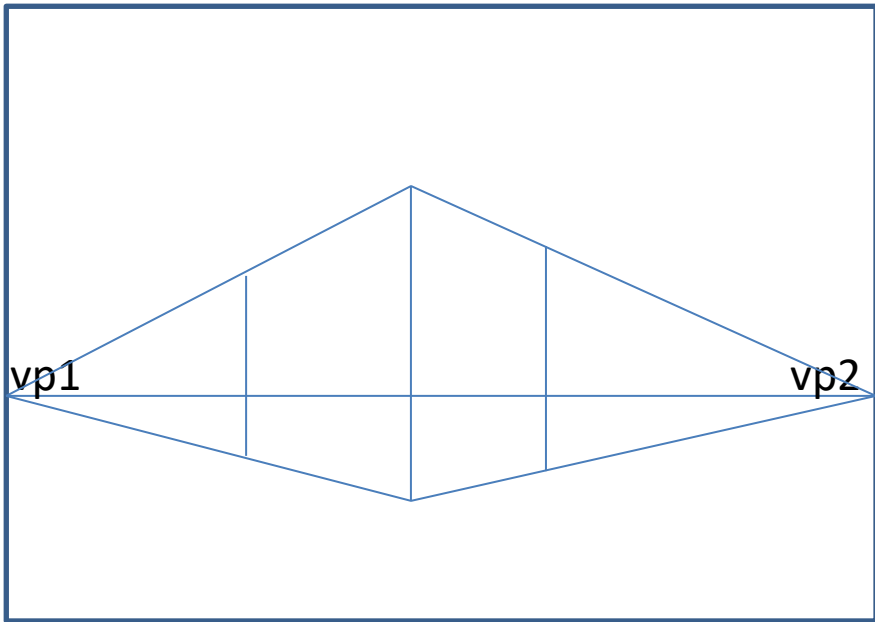

5mm

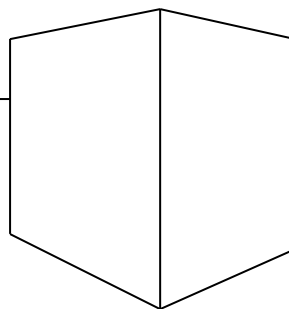
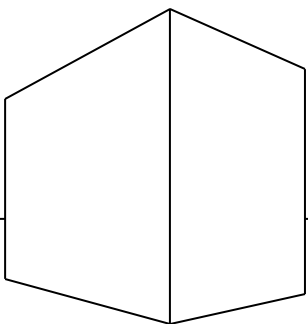

1cm

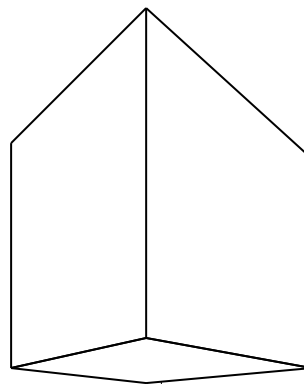
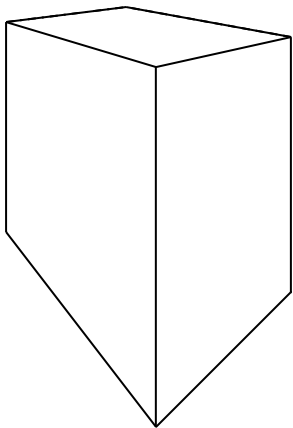

Three Point Perspective



